

# Vision Express S5 User Manual

© 2018 Vision Engraving & Routing Systems



# Vision Express S5 User Manual

© 2018 Vision Engraving & Routing Systems

All rights reserved. No parts of this work may be reproduced in any form or by any means - graphic, electronic, or mechanical, including photocopying, recording, taping, or information storage and retrieval systems - without the written permission of the publisher.

Products that are referred to in this document may be either trademarks and/or registered trademarks of the respective owners. The publisher and the author make no claim to these trademarks.

While every precaution has been taken in the preparation of this document, the publisher and the author assume no responsibility for errors or omissions, or for damages resulting from the use of information contained in this document or from the use of programs and source code that may accompany it. In no event shall the publisher and the author be liable for any loss of profit or any other commercial damage caused or alleged to have been caused directly or indirectly by this document.

Revised: 12/7/2018

# Table of Contents

|  |            |
|--|------------|
| <b>Part I Introduction</b>                             | <b>5</b>   |
| 1 Disclaimer and Warranty Information.....             | 6          |
| 2 Safety Precautions.....                              | 8          |
| <b>Part II General Information</b>                     | <b>11</b>  |
| 1 Unpacking & Inventory.....                           | 11         |
| 2 Machine Description & Terminology.....               | 12         |
| <b>Part III Installation</b>                           | <b>15</b>  |
| 1 Computer Requirements.....                           | 15         |
| 2 Vision Software.....                                 | 16         |
| 3 Machine Connections.....                             | 27         |
| Direct Connection to Computer .....                    | 29         |
| Network Connection .....                               | 35         |
| <b>Part IV The Front Panel</b>                         | <b>42</b>  |
| <b>Part V Step by Step Operation</b>                   | <b>49</b>  |
| 1 Holding Down Material.....                           | 49         |
| 2 Zeroing the Cutter.....                              | 51         |
| 3 Proximity Sensor.....                                | 51         |
| 4 Step by Step Operation.....                          | 53         |
| Diamond Drag Engraving .....                           | 53         |
| Example Job 1 - Diamond Drag.....                      | 54         |
| Rotary Engraving .....                                 | 66         |
| Example Job 2 - Rotary Engraving.....                  | 67         |
| Burnishing .....                                       | 71         |
| Example Job 3 - Burnishing.....                        | 74         |
| Profile Cutting .....                                  | 84         |
| Example Job 4 - Profile Cutting.....                   | 85         |
| Vectorizing Bitmaps and Creating Vector Fills .....    | 90         |
| Vectorizing a Bitmap in Vision Express 9 Software..... | 90         |
| Vector Hatch Fills.....                                | 93         |
| 5 Advanced Operation.....                              | 100        |
| Setting and Using Custom Home Positions .....          | 100        |
| Using the Measure Feature .....                        | 102        |
| Using the Red Dot Laser Pointer for Positioning .....  | 105        |
| Creating a Center Driver .....                         | 108        |
| Adjusting Spindle Pressure .....                       | 116        |
| Installing Additional Drivers .....                    | 119        |
| <b>Part VI Maintenance</b>                             | <b>122</b> |
| 1 Multi Mat Information.....                           | 122        |

|   |   |     |
|---|---|-----|
| 2 | Cleaning.....                             | 122 |
| 3 | Motion System Cleaning & Lubrication..... | 124 |
| 4 | Changing the Motor Belt.....              | 133 |
| 5 | Changing the Motor Brushes.....           | 137 |
| 6 | Cleaning the Fan Filter.....              | 138 |

## **Part VII Troubleshooting** **139**

|   |                          |     |
|---|--------------------------|-----|
| 1 | Engraving Problems.....  | 139 |
| 2 | Mechanical Problems..... | 142 |

## **Part VIII Optional Accessories** **144**

|   |                                 |     |
|---|---------------------------------|-----|
| 1 | Vacuum Chip Removal System..... | 144 |
| 2 | Quick Lock Vise.....            | 145 |
| 3 | Hold Down Clamps.....           | 146 |
| 4 | Fixtures.....                   | 148 |
| 5 | Clamping Vises.....             | 151 |

# 1 Introduction

## About This Manual

This manual provides you with information about the Vision Engraving or Routing system. Beginning with unpacking the machine and continuing through installation, operation and lifetime machine maintenance. This manual does not teach the user how to become an expert in engraving, computer usage, or engraving software. Some previous knowledge of engraving terms and the engraving process is beneficial. **For information on the Vision Engraving Software, see the Vision Engraving Software manual.** For more information on your individual computer system, see your computer's user manual or contact your computer distributor.

**To begin, locate the White/Blue Dongle or Silver Dongle or Blue/Silver USB Stick included with your machine in the Accessories Box**

## Important Note:

**The Vision software is available in two versions; one with a dongle, and one that is "dongle-less" and is loaded on to a USB Memory stick.**

**If your machine was delivered with, or you currently have the white/blue or orange software dongle, DO NOT LOSE IT!**

**The Vision software will NOT run without the dongle plugged into the computer.**

## USB Stick



## Dongles



## 1.1 Disclaimer and Warranty Information

### Limits of Liability / Disclaimer of Warranty

The information contained within this manual has been carefully checked and is believed to be accurate, however, Vision makes no representations or warranties for this manual, and assumes no responsibility for inaccuracies, errors, or omissions that may be contained within this manual. In no event shall Vision be liable for any loss of profit including (but not limited to) direct, indirect, special, incidental, consequential, or other damages resulting from any defect or omission in this manual, even if previously advised of the possibility of such damages.

In the interest of continued product development, Vision reserves the right to make improvements to this manual and the products it describes at any time, without notice or obligation.

### Limited Warranty:

#### Vision Computerized Engraving and Routing Systems (and Retrofit Tables)

Vision Computerized Engraving and Routing Systems (Vision) warrants that for a period of one (1) year from the date of shipment to the original purchaser of an Express, VE810, or VR48 or a period of two (2) years from the date of shipment to the original purchaser for a Phoenix1212, 1612Pro, 1624Pro, 2424, 2448, 2525Router, 2550Router, MaxPro, The MAX, or Table Retrofit (the System), that the System will be free from defects in material and workmanship under normal use and service. Upon written notification, we will transfer the remaining warranty to a new customer. This warranty shall cover all elements except for items covered by separate manufacturer's warranties and consumable items. "Consumable" items include, but shall not be limited to, belts, brushes, lubricants, and cutters furnished with the System, for which no warranty is provided.

In the event a defect is discovered during the warranty period, within thirty days of discovery, but no later than the last day of the warranty period as described above, the user shall contact Vision for instructions regarding disposition of the problem. Vision shall, at its option, either (1) repair the affected product with new or refurbished parts, or (2) provide a replacement. Any incidental costs, including the cost of shipment from the user's location to the point of repair and return, and any installation performed by the user, shall be at the expense of the user.

This warranty covers normal use only and shall be void in the event that the System is altered or modified without authorization by Vision, or is subject to abuse, neglect, or other misuse by the user.

The warranties for Third-Party Hardware and Third-Party Software shall run directly from the manufacturers of such hardware and software to the user. Vision makes no warranties, expressed or implied, with regard to Third-Party Hardware or Third-Party Software.

Vision does not warrant any product, component, or part not manufactured by Vision that was not supplied by Vision. (Third-party items, including but not limited to software, are subject to their own manufacturer's warranties.) Vision does not warrant defects caused by a failure to provide a suitable environment for the system, by unauthorized attachments, by modifications or repairs other than by Vision, by use of the System for other than its original intention, or by other misuse or abuse of the System.

### Extended Warranty

An Extended Warranty may be purchased which extends the terms of the original equipment Warranty in 1 year increments for a period of up to 30 days after the original equipment Warranty expires. An Extended Warranty may also be purchased for a period of up to 30 days after an existing Extended Warranty expires. Extended Warranties cannot be purchased on any equipment that is 7 or more years old, or if there is a Lapse of Warranty. Age of equipment is determined from the date of shipment to the original buyer.

**Lapse of Warranty**

If an Extended Warranty is not purchased within 30 days of the expiration of the original equipment Warranty, or within 30 days of the expiration of an existing Extended Warranty, the equipment will be in Lapse of Warranty. An Extended Warranty can never again be purchased for any equipment that is in Lapse of Warranty. It is the responsibility of the purchaser of the equipment to maintain accurate records and to know the expiration date of any Warranty.

The above and foregoing is the only warranty of any kind, either expressed or implied, by statute or otherwise, regarding the System, its fitness, quality, merchantability, or otherwise. Any warranties implied by law are hereby expressly disclaimed. No oral or written information or advice given by Vision, its Dealers, Distributors, Agents, or Employees shall create a warranty or in any way increase the scope of this warranty. Neither Vision, nor anyone else who has been involved in the creation, production, or delivery of the System shall be liable for any direct, indirect, consequential, or incidental damages (including damages for loss of business profits, business interruption, loss of business information, and the like) arising out of the use of, or inability to use, the product.

Any software supplied by Vision in conjunction with the purchase of the System for use therewith shall be governed by its own separate software license and warranty agreement.

Terms and Conditions are subject to change

**For Warranty Service Call: (602) 439-0600**

**Please have your machine serial number ready before calling.**

Vision Engraving & Routing Systems is owned and operated by Western Engraver's Supply, Inc.  
Phoenix, Arizona, USA

## 1.2 Safety Precautions

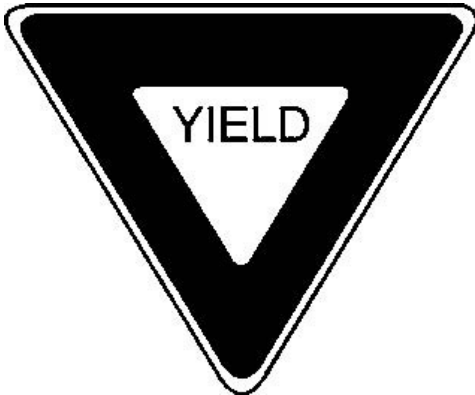

- Ø **WARNING:** Do not attempt to operate this equipment until you have read and understood the instructions in this User's Manual! Failure to comply may result in damage to the equipment and/or inflict serious personal injury!
- Ø Only trained personnel should operate the Vision Engraver or Router. All individuals operating this equipment must read and understand the User's Manual and have been trained by a competent authorized user.
- Ø Use of this equipment by unauthorized and/or untrained personnel may result in damage to the equipment and/or inflict serious personal injury.
- Ø Never use this equipment in a hazardous environment. Do not store or use this machine outdoors. Do not run this machine in an extremely hot environment.
- Ø Place the equipment in a location with low humidity and a minimum of dust. Avoid placing in direct sunlight or in locations with excessive heat.
- Ø Do not expose the equipment to rain or use near water. You can clean the equipment with a damp cloth, but be sure to unplug it first.
- Ø Follow the maintenance instructions for proper cleaning of the air filter if equipped.
- Ø There are no serviceable parts inside the controller. Please contact qualified service personnel for any service issues.
- Ø Openings and/or fans are provided on machines and controllers. Do not cover them or place in an environment where they may become blocked. Never insert anything into the openings or fans as doing so may create danger of electric shock.
- Ø Always stop the machine before making any adjustments.



- Ø Keep hands clear of the bottom of the spindle during operation.
- Ø Do not operate the machine with the covers removed.
- Ø Use extreme caution when inserting or removing cutters
- Ø Before servicing, disconnect the power cord.
- Ø To avoid electric shock or equipment damage, connect power to this machine according to this guide and in compliance with all applicable laws and regulations.
- Ø Never operate the equipment with damaged or frayed power cords, loose connections, or exposed extension cords where the cord could create a tripping hazard.
- Ø Be sure to hold the plug, not the cord, when disconnecting the machine from a power source.
- Ø Keep work area clean. Remove adjustment tools from the machine prior to start-up. Cluttered work areas increase the potential for accidents.
- Ø Safety glasses should be worn at all times as chips and other debris may become airborne.
- Ø Avoid loose clothing, neckties, gloves, rings, bracelets, jewelry and other items that may get caught in moving parts.
- Ø If your machine does not operate properly; in particular, if there are any unusual sounds or smells coming from it, immediately unplug it and contact Vision's service department or your local distributor.
- Ø Unplug the machine when it is going to be left unused for an extended period of time.
- Ø Operators should inspect the machine daily for damage or modifications. Under no circumstances should the machine be operated if there is any doubt about the machine condition. If there are any questions call the Vision technical support team at 602-439-0600.
- Ø Keep a safe distance away from the machine while running.
- Ø Keep children away from work area at all times. Visitors should be a at least 3 feet from working area.
- Ø Do not operate this or any machine while under the influence of drugs or alcohol.
- Ø Keep hands away from the spindle at all times when spindle is rotating and/or machine is moving. Always wait for spindle to stop rotating before attempting to insert or change a tool.

Do not try to stop the spindle manually with your hands or other devices. Failure to comply with these instructions may result in serious personal injury!

- Ø Never leave the machine unattended.
- Ø Press any Emergency switch to stop the machine immediately. Be familiar with the location of all emergency stop switches.
- Ø Make sure workpiece is properly fastened to table before starting the job.
- Ø Turn on the vacuum table (if equipped) or make sure clamps and other fixtures are fastened. If workpiece moves during operation you can damage the machine, the workpiece, and serious personal injury may occur to the operator.
- Ø Only use the machine and its attachments for the applications they were designed for. Forcing the machine or its attachments to do work it was not intended to do may cause permanent damage to the machine and serious injury may occur to the operator. If there are any questions about the abilities of your machine, please call the Vision technical support team at 602-439-0600.
- Ø Do not force the machine to work at excessive speeds. The machine will work safely under normal speeds which are material and application dependent. Using excessive speeds may damage tooling, material, the machine, and may cause serious injury.
- Ø Do not power on the machine when servicing.
- Ø Do not power on the machine when installing or replacing parts and/or accessories.
- Ø Turn power to the machine OFF when not in use.
- Ø Perform the required maintenance at the recommended intervals.
- Ø Use the general maintenance guidelines to properly maintain your machine.
- Ø A disciplined approach to preventative maintenance can extend the useful life of any machine, improve cut quality, and reduce repair costs. Keep records of what and when you perform maintenance duties.

## 2 General Information

### 2.1 Unpacking & Inventory

The Express engraving system has been shipped in one carton, unless other accessories have been ordered with the machine that will not fit in the box. Examine the condition of the box for external damage. In the event of apparent external damage, notify your shipping carrier upon receipt, and call your sales representative or Vision immediately.

**Note:** The shipping container is considered reusable and should be stored for use in the event of service need or upgrade.

**Step 1:**

Open the foam packed shipping carton. In the top of the carton will be a cardboard box with all of the machine accessories. The following items should be included:

- ✓ 1 Express Machine
- ✓ 1 Express Warranty Card
- ✓ 1 Express Installation Guide
- ✓ 1 White/Blue or Orange USB security dongle - Contains User Manual and Vision Software
- ✓ 1 Ethernet Network Cable (P/N 20-1074-00)
- ✓ 1 Power Cord
- ✓ 1 External Power Supply (P/N 27-0050-00)
- ✓ 1 0.015 FLX Plastic Cutter (P/N AC-175.015-FLX)
- ✓ 1 Non-Rotating Diamond 120 Degree (P/N NRD-171-120)
- ✓ 1 6 x 8 inch Multi Mat Material (P/N 15-1109-00)
- ✓ 1 Spare Motor Belt (P/N 200507-14.75)
- ✓ 1 Allen Wrench Set
- ✓ 1 Cutter Wrench (P/N 200538-00)
- ✓ 1 Technical Support Label
- ✓ 1 Accessory Sheet

Check to see that all of the items are included. Should any of the contents be missing, damaged, or of the incorrect type, please call your sales representative or Vision immediately.

**Step 2:**

Prepare a clean, level surface to put the engraving machine on. Carefully lift the machine out of the carton and place it on the table.

**Step 3:**

After unpacking the machine, make sure that you SAVE THE CARTON, FOAM PACK and ANY OTHER BOXES. They can be reused in the event the system must be transported to another location or returned for service. Improper packaging for shipment can damage the machine and may void the warranty.

## 2.2 Machine Description & Terminology

This chapter briefly describes the major components of the Express engraver and will help you identify the parts of your engraver which are discussed elsewhere in this manual.

### SPECIFICATIONS:

|   |  |
|---|--|
| Z-Axis Clearance:   | 1.25 inch (31.75 mm)   |
| (Definition: the distance between the bottom of the spindle and the work surface) |  |
| Z-Axis Stroke:  | 1.25 inch (31.75 mm)   |
| (Definition: the travel distance of the Z-axis mechanism or spindle)              |  |
| Table Resolution:   | .0002 inch   |
| (Definition: the smallest controlled motion the table is capable of)              |  |
| Maximum Speed:  | 2 inches per second (50.8 mm/s)                                      |
| Spindle Type:   | 11/64 inch (4.366 mm) top load                                       |
| Maximum Work Area:  | 6 inch x 8 inch (152.4 mm x 203.2 mm)                                |
| Maximum Work Piece Size   | 8 inch (203.2 mm) x Unlimited  |
| Overall Dimensions H x W x D:   | 9.5 inch x 17.5 inch x 17.5 inch<br>(241.3 mm x 444.5 mm x 444.5 mm) |
| Table Top:  | T-Slot   |
| Interface:  | Ethernet   |
| Controller:   | Embedded   |
| Power Requirements:   | 100 - 240 VAC  |
| Shipping Weight:  | 52 lbs. Ground, 61 lbs. Air  |
| Actual Weight:  | 24 lbs.  |
| Shipping Dimensions:  | 23" x 23" x 19"  |

### DEFINITION OF TERMS (see Figures below)

1. **Front Panel** - Allows the user to start, pause, and resume operation. The user can also jog, set home, load and save jobs, configure settings and many other actions. For complete details see the Front Panel section of this manual.

2. **Emergency Stop** - A push button emergency shut down of the motion system (does not turn machine completely off, stops motion by cutting power to the spindle motor and stepper motors).

**Figure 1.1**

**Figure 1.2**



3. **X-Axis Leadscrew** - The screw that drives the left to right motion of the machine.
4. **X-Axis Linear Rail** - The square rail that the carriage assembly rides on.
5. **Y-Axis Linear Rail** - The square rail that the t-slot table rides on.
6. **Y-Axis Leadscrew** - The screw that drives the front to back motion of the machine.
7. **T-Slot Table (work surface)** - Allows the user to position the engraving material or special clamps and fixtures. The slots in the table are shaped with an upside-down T. The slots are used to hold various accessory holders, clamps, and jigs.
8. **Table Home Position** - The upper-left corner of the T-Slot table. All work is referenced from this position.
9. **Spindle Cover** - Protects user from rotating spindle during operation.

Figure 1.3

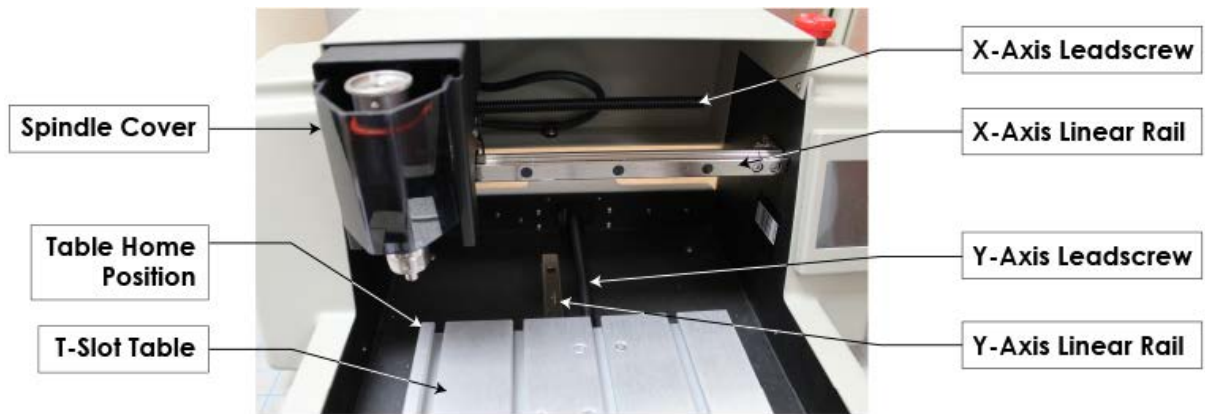

10. **Spindle** - Holds various cutters and allows for cut depth adjustments.

11. **Motor Belt** - Supplies rotary motion to the spindle.

12. **Spindle Motor Pulley (not shown)** - Behind the spindle, and attached via the motor belt, the motor pulley drives the spindle rotation when rotary engraving or cutting. (The spindle motor pulley is hidden by two covers).

13. **Spindle Pulley** - The top part of the spindle where the motor belt rides.

14. **Spindle Micrometer** - The part of the spindle that the user adjusts to set engraving depth.

15. **Spindle Nose Cone** - The part of the spindle that rides on top of the material while engraving. Cutting depth is determined by the distance the cutting tool extends below the bottom of the nose cone.

Figure 1.4

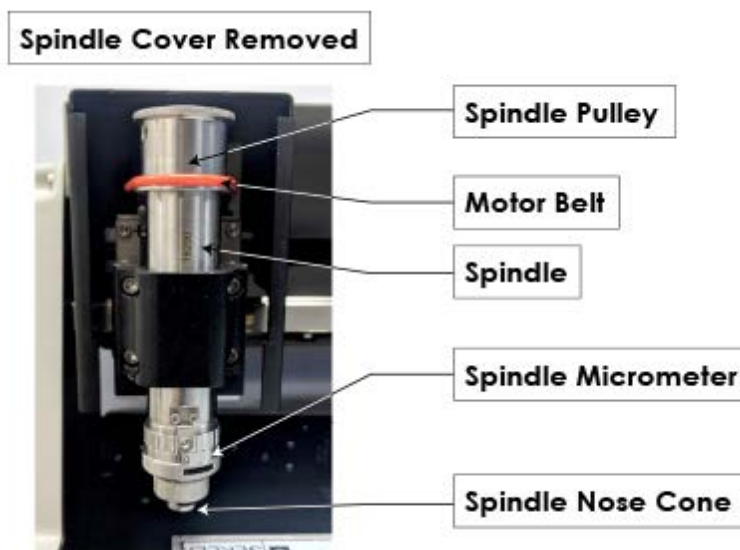

## 3 Installation

NOTE: IT IS HIGHLY RECOMMENDED THAT THE COMPUTER USED TO OPERATE THE VISION ENGRAVER OR ROUTER BE CONNECTED TO THE INTERNET. THIS ALLOWS THE USER TO ALLOW VISION'S TECHNICAL SUPPORT TO ACCESS THE MACHINE AND TROUBLESHOOT IF NECESSARY.

### 3.1 Computer Requirements

#### Minimum System Requirements:

|                   |  |
|-------------------|--|
| CPU:              | Dual Core (2.0GHz or higher)   |
| Hard Drive:       | 750 GB free space  |
| RAM:              | 1GB + OS Requirements  |
| Operating System: | Windows 10 (32/64 bit)<br>Windows 8 (32/64 bit)<br>Windows 7 SP.1 (32/64 bit) ***Requires Service Pack 1 |
| Ports:            | USB port for security dongle<br>Local or network Ethernet port to connect machine                        |

#### Suggested System Requirements

|                   |  |
|-------------------|--|
| CPU:              | Core i3 (or faster)  |
| Hard Drive:       | 1 TB (or more)   |
| RAM::             | 4GB + OS Requirements  |
| Operating System: | Windows 10 (32/64 bit)<br>Windows 8 (32/64 bit)<br>Windows 7 SP.1 (32/64 bit) ***Requires Service Pack 1 |
| Ports             | USB port for security dongle<br>Local or network Ethernet port to connect machine                        |

## 3.2 Vision Software

Insert the Vision USB dongle into the USB port on the computer. Navigate to the Devices and Drives area on your PC. Double click on the Vision icon to open the files on the USB dongle.

Select the Start or Start.exe file to begin.

| <input type="checkbox"/>            | Name                      | Date modified      | Type                  | Size       |
|-------------------------------------|---------------------------|--------------------|-----------------------|------------|
|                                     | cdmdata                   | 7/31/2018 3:54 PM  | File folder           |            |
|                                     | ClipArt                   | 7/30/2018 4:29 PM  | File folder           |            |
|                                     | Vision Pro dongle driver  | 7/30/2018 4:16 PM  | File folder           |            |
|                                     | Vision Screen Backgrounds | 7/30/2018 4:16 PM  | File folder           |            |
|                                     | VPro                      | 7/31/2018 12:57 PM | File folder           |            |
|                                     | AUTORUN.INF               | 7/31/2018 4:42 PM  | Setup Information     | 1 KB       |
|                                     | ProductS.ini              | 8/1/2018 1:57 PM   | Configuration sett... | 1 KB       |
|                                     | ProductS.lcf              | 8/1/2018 1:57 PM   | LCF File              | 3 KB       |
|                                     | slcdmenu.cdi              | 7/31/2018 4:42 PM  | CDI File              | 10 KB      |
|                                     | SLCDMENU.EXE.manifest     | 8/24/2015 1:02 PM  | MANIFEST File         | 1 KB       |
| <input checked="" type="checkbox"/> | Start.exe                 | 1/17/2017 6:10 PM  | Application           | 391 KB     |
|                                     | Version 2.02 S5.txt       | 6/19/2012 9:52 AM  | Text Document         | 0 KB       |
|                                     | Vision Software.msi       | 8/1/2018 1:47 PM   | Windows Installer ... | 579,809 KB |
|                                     | VISION.ICO                | 1/5/2012 11:11 AM  | Icon                  | 289 KB     |

Click on the Install Vision Software button.

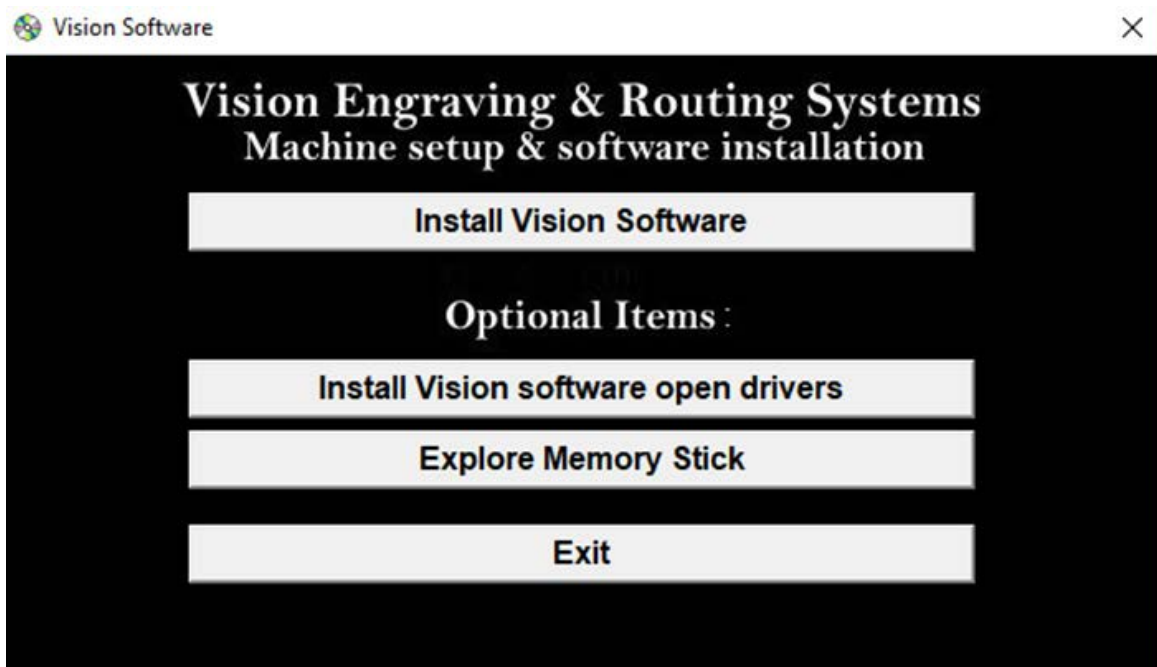



The Vision S5 Software Wizard will guide you through the process of installing the software. Press Next to continue.

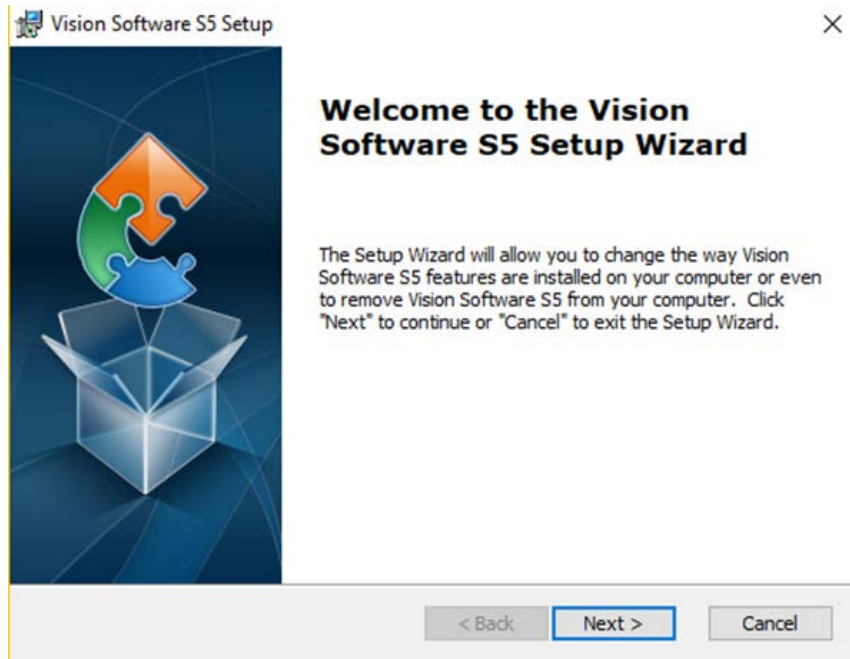

Press Install to continue

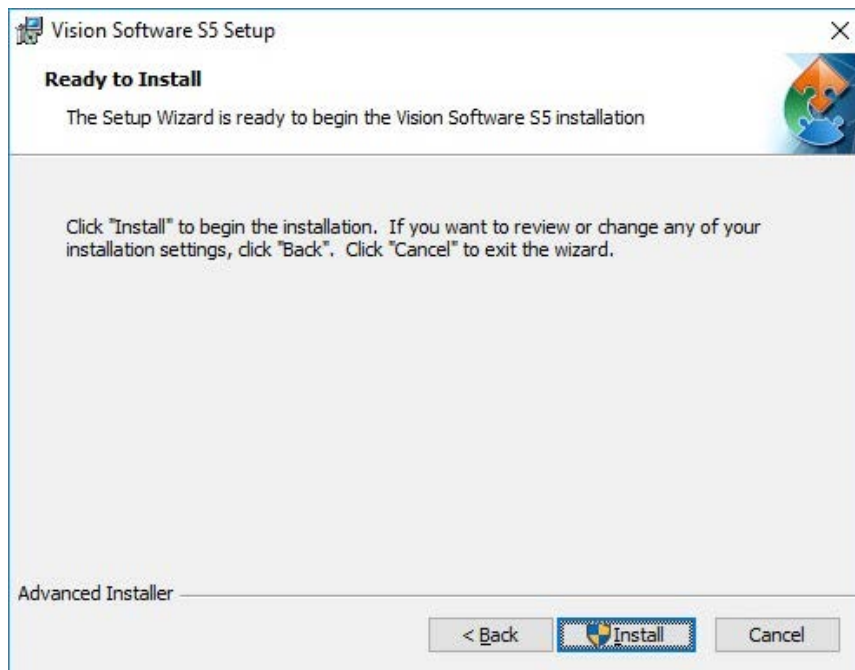

Setup wizard will install the program.

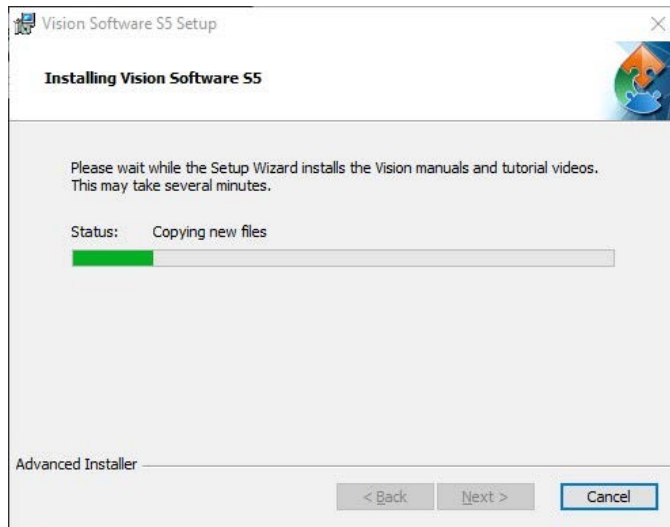

Select Finish to continue the software installation.

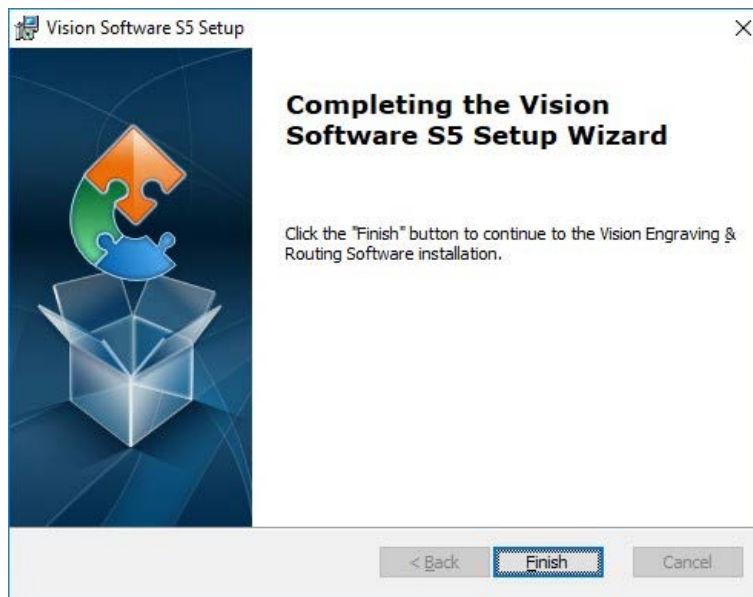

Choose your preferred language and click ok.

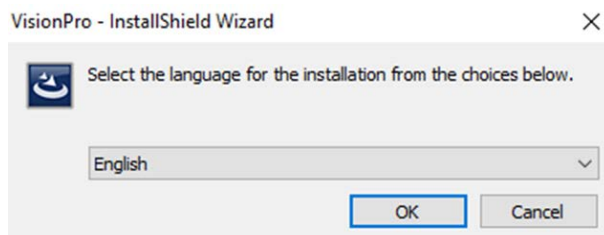

The Vision 10 Setup Screen will appear. Press Next.

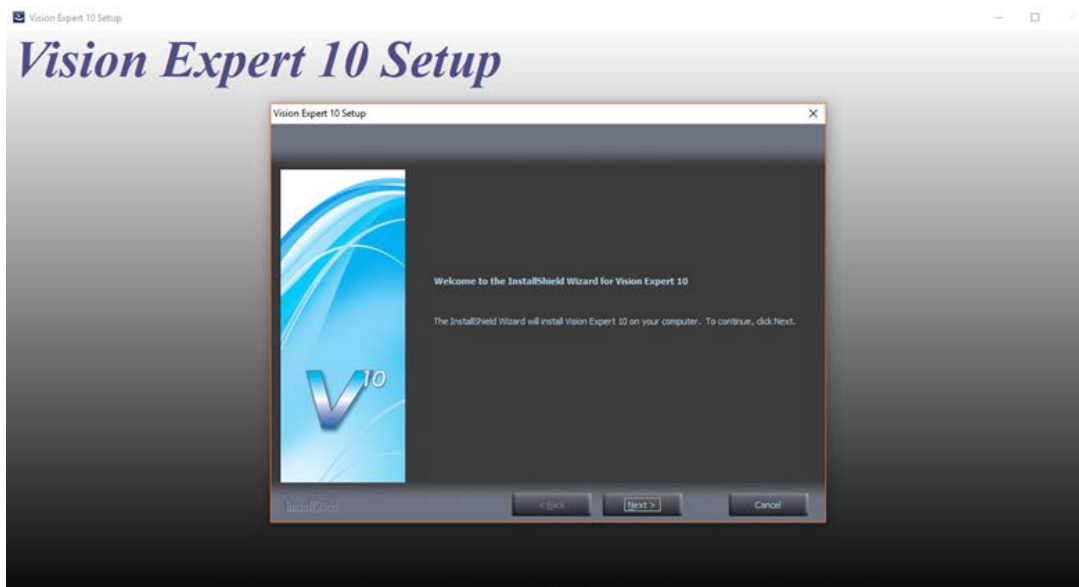

After accepting the license agreement, click on the Next button.

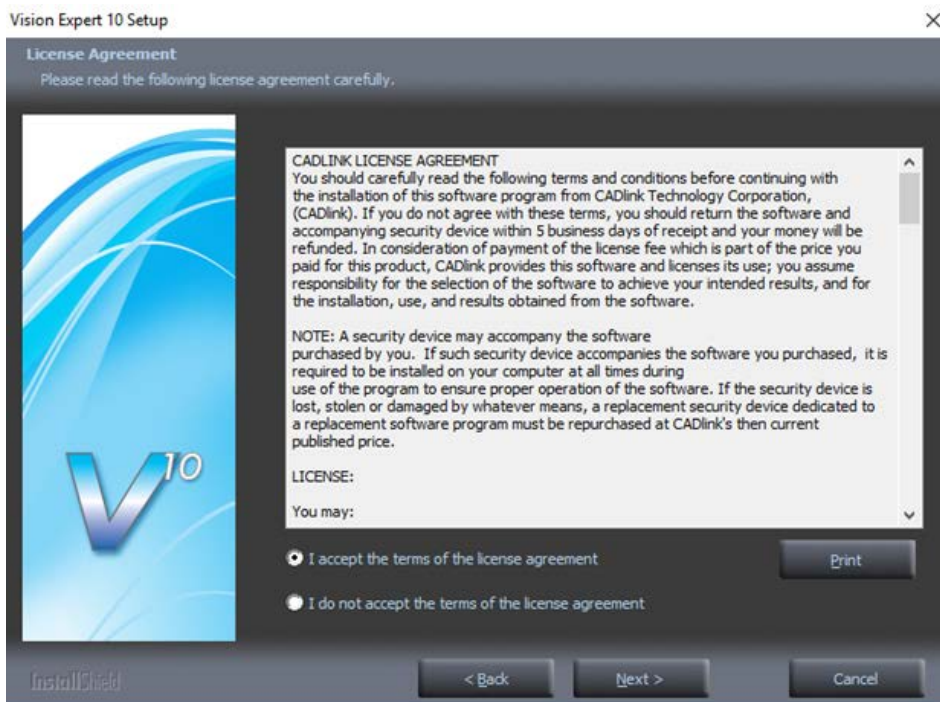

Select Next (or change the destination folder - not recommended).

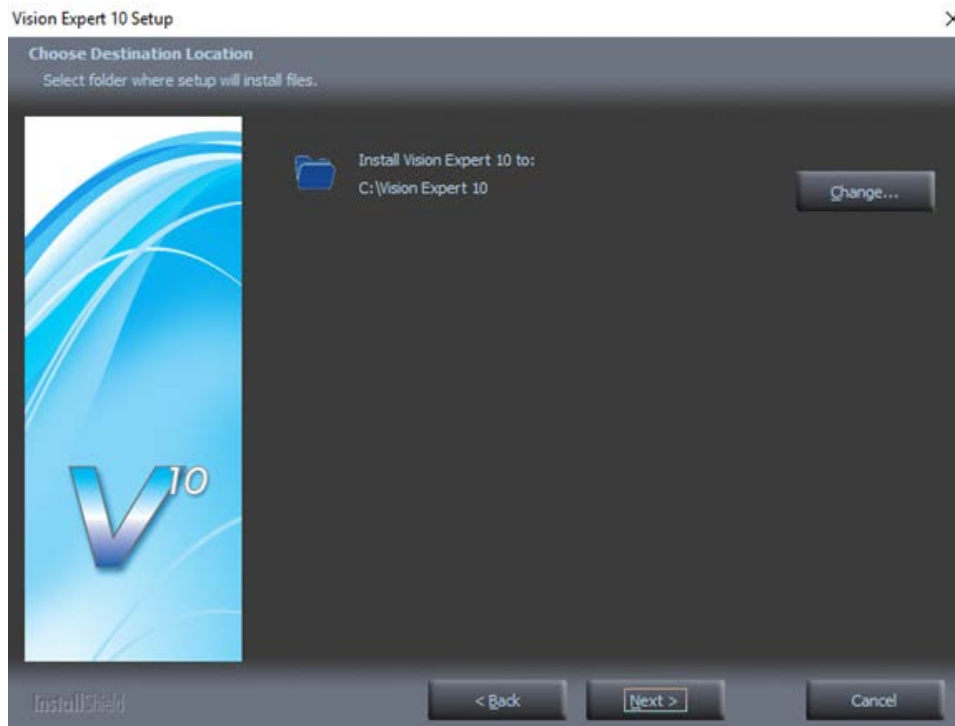

Select Next to create the folder.

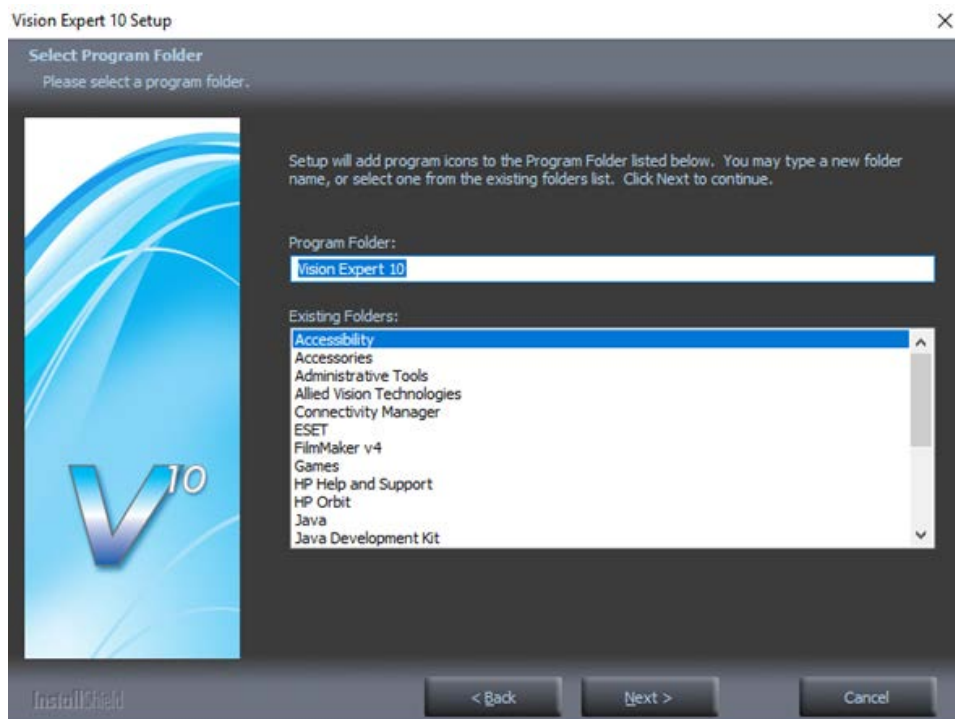

The installation will continue.

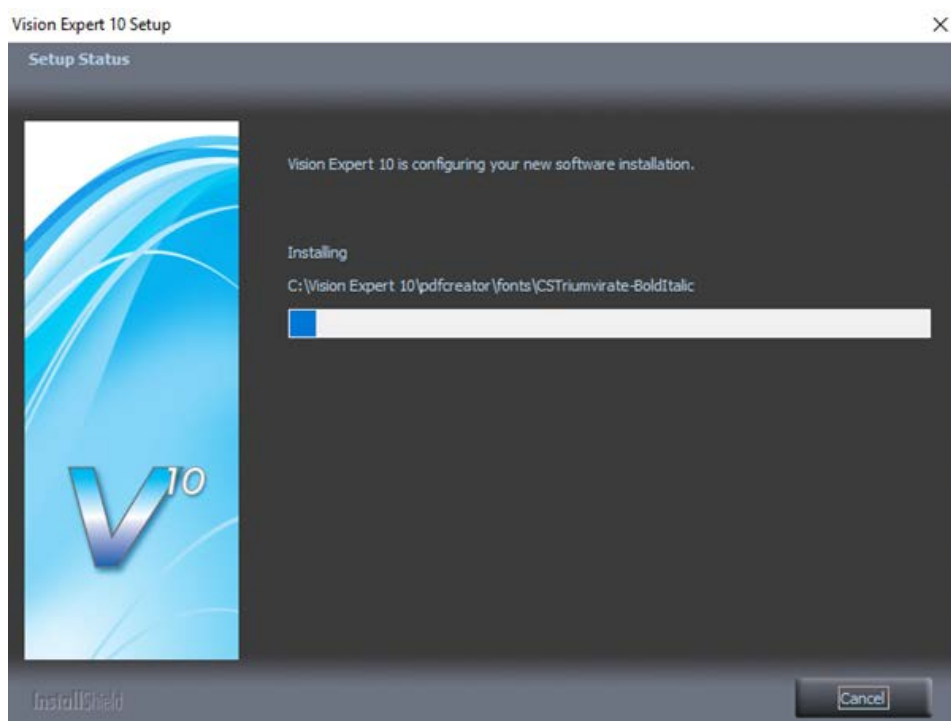

Select the Express S5 by placing a check mark in the box to the left of Express in the Manufacturer list, then select Next. If you purchase another engraving system from Vision, it can be added to the machine list at a later date from within the Vision software.

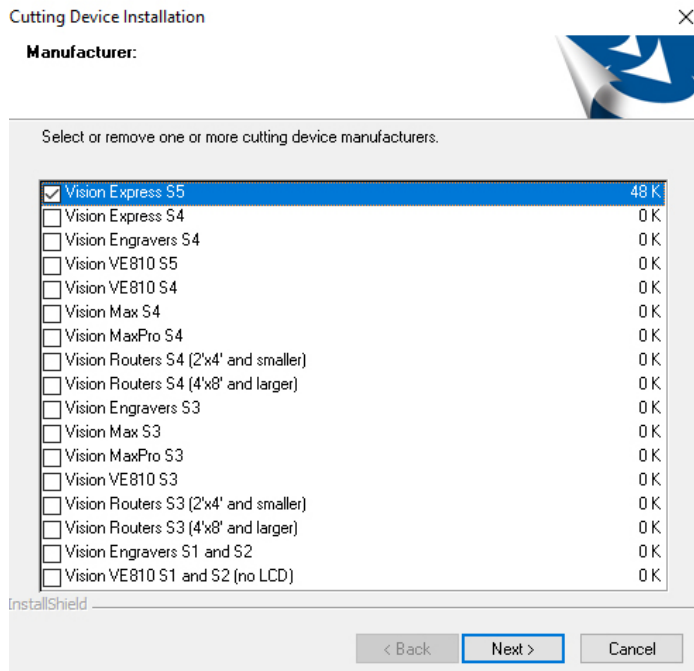

Select the Express S5. Note – The Express Vice/Center Origin S5 is used when using the center vice accessory.

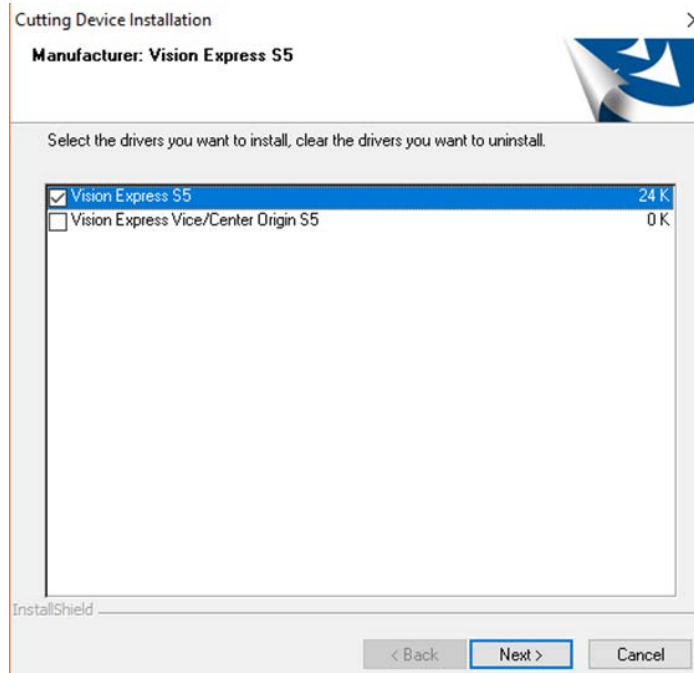

Select Continue to install True Type fonts and Vision Engraving Fonts on your computer.

#### Font Installation

Welcome to the Vision Expert Font Installation Wizard. To use a font in Vision Expert, it must be installed.

Clicking Continue will start the installation of TrueType fonts, Vision Pro VEF fonts, Corel WFN fonts and Adobe Type1 fonts.

Skip

Continue

#### Install TrueType Fonts

Now installing fonts that are present on your system.

Searching for fonts...

77 fonts found.

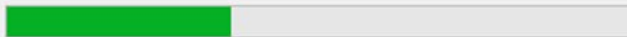

Click yes to install all additional fonts from your C:\ Drive.

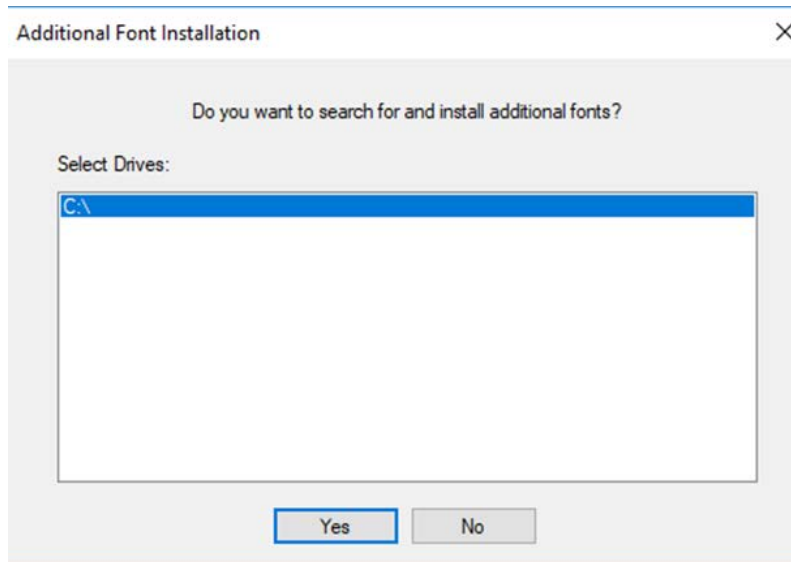

All system fonts will be installed.

#### Installing Additional Fonts On Local Disks

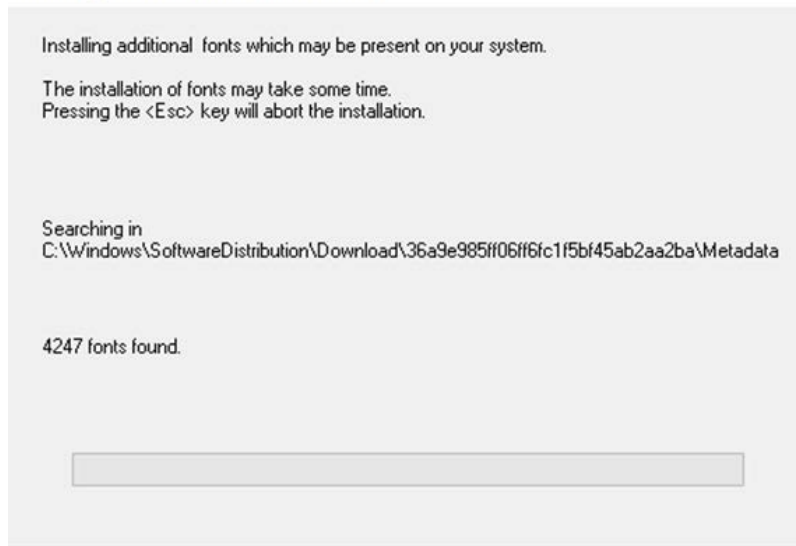



Press OK

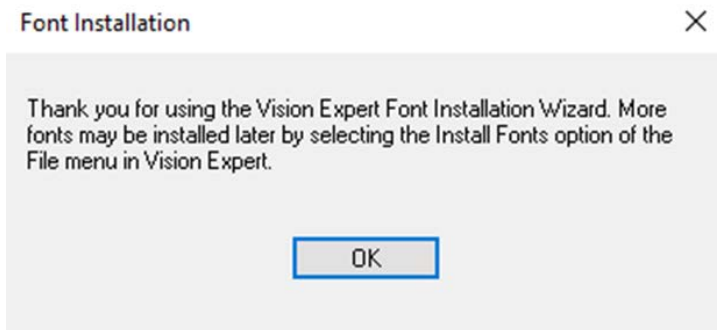

Press on the Finish button.

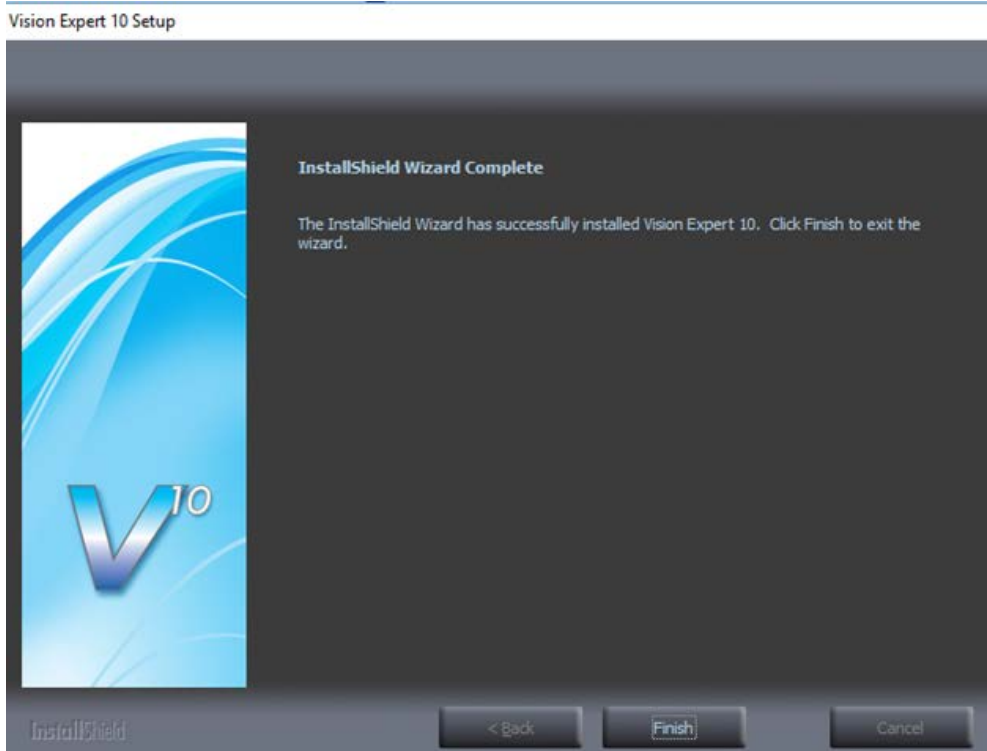

Press the Exit button .

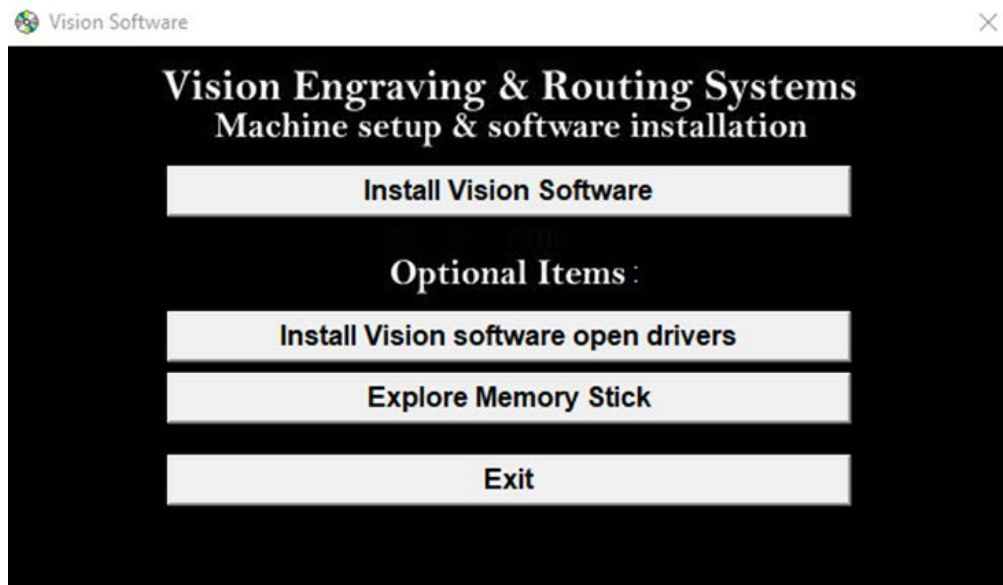

The Vision manuals icon should now appear on your computer's desktop along with an icon for your version of Vision 10 software.



### 3.3 Machine Connections

On the rear of the Express, there are four connection ports. The input power, the RJ-45 Ethernet port, the USB port and the remote vacuum chip removal system on/off port.

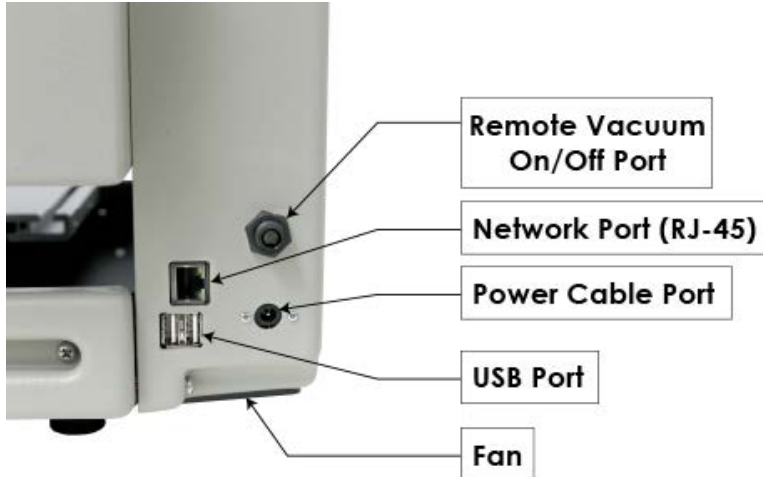

Connect the power supply cord to a 100 - 240 volt AC power source. Then plug the power cable into the port on the back of the machine. Plug one side of the network cable (black network cable) to the back of the machine and the other side to either the PC Ethernet port, a network switch box or a company network port.

**NOTE:** The Ethernet crossover cable is gray and should not be needed.

If the emergency stop screen appears on the LCD when the machine is powered on, then the emergency stop button is pressed in. Release the button twisting it until it "pops up". This will clear the emergency stop screen.



The Express IP address configuration setup will vary depending on how it is connected to the PC.

The two options for connecting the Express to the computer are:

- Direct connection to the computer or direct connection using a network hub or switch. Both of these methods require the same setup.

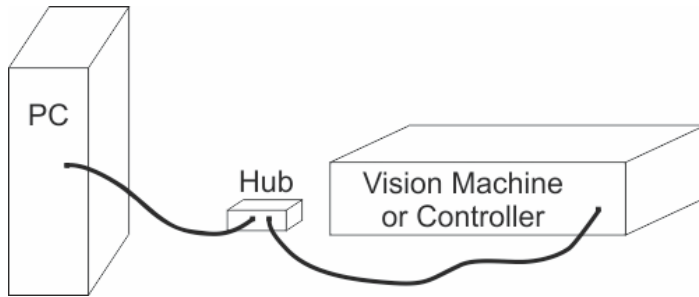
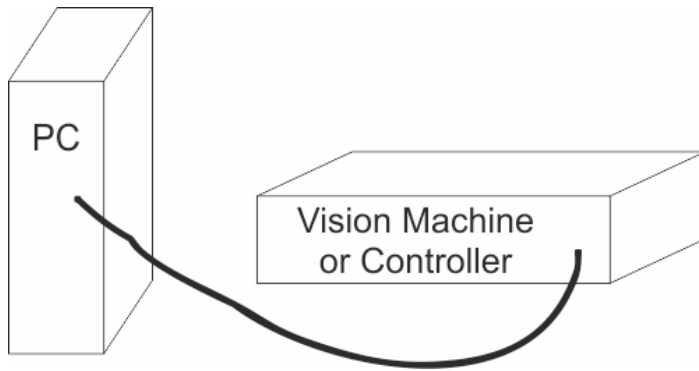

- Connection through a company network

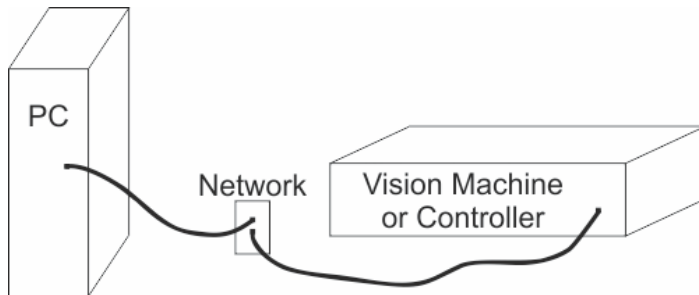

Follow the steps from one of the two sections below to configure the IP address depending on the connection type above.

### 3.3.1 Direct Connection to Computer

Direct connection to the computer or direct connection using a network hub or switch.

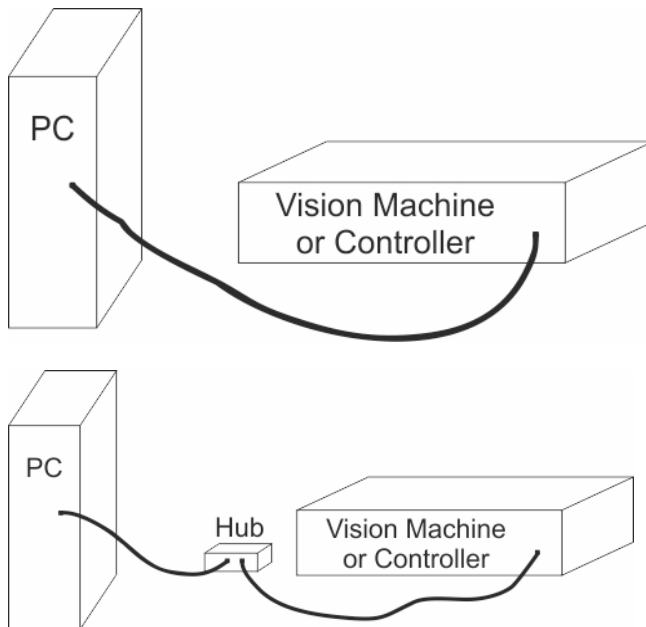

Once the machine is connected directly to the computer's network port or is connected directly to a network hub or switch with the black Ethernet cable, power the machine on. The power switch for the Express is located on the power supply box for the machine. Once the machine has initialized, the home screen will appear on the LCD screen.

Select the Settings Screen icon.



Select the Connectivity Screen icon.

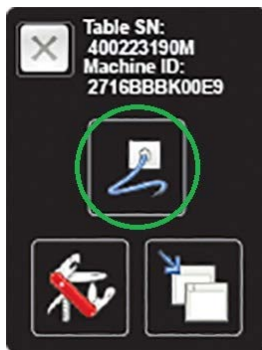

Confirm that the LCD shows the Mode is set to static.



If the Mode displays DHCP, press the mode icon. This will change the Mode to display Static.



Confirm that the LCD shows the Address is set to 192.168.5.101.

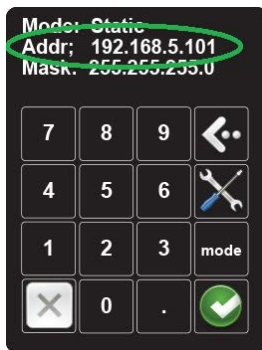

If the Address is not set to 192.168.5.101, it will need to be changed. Press the tools icon.

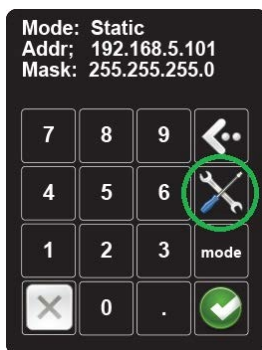

Enter the numbers 192.168.5.101 with the numbers on the LCD. If you make a mistake, you can press the left arrow to erase a number.

Press the green check mark to accept the value.

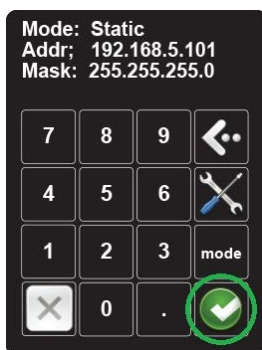

The Mask value will be blank. Press the green check mark a second time and the mask will change to 255.255.255.0.

If the Mask does not change to this value, enter it with the numbers on the LCD.

The LCD should now look like below:

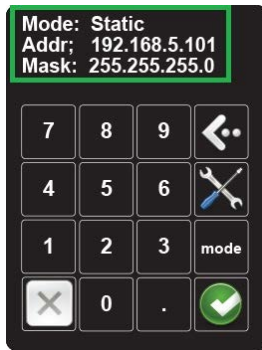

Press the X to exit the connection screen.

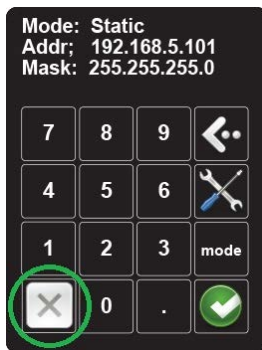

Press the X to return to the home screen.

NOTE - This follow section is shown on a Windows 10 PC. For Windows 7 or Windows 8, the screens are slightly different.

The IP address of the computer IP address will need to be set to match the machines network settings.

To set the computer's IP address, right click on the network icon in the lower right corner of the Windows desktop screen.



Select "Open Network & Internet settings". (In Windows 7 and Windows 8 select "Open Network and Sharing Center")

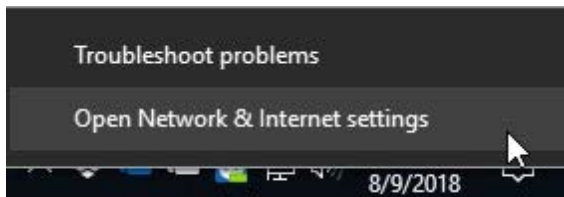

Select "Change adaptor options". (In Windows 7 and Windows 8 select "Change adapter settings")



## Change your network settings

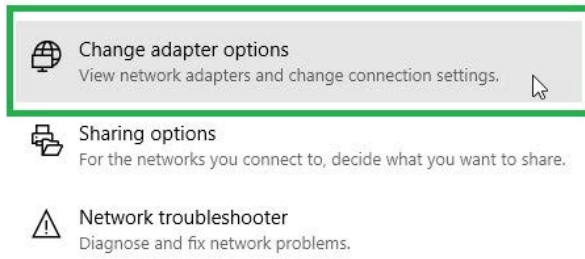

Right click on the Ethernet adapter shown and select "Properties".

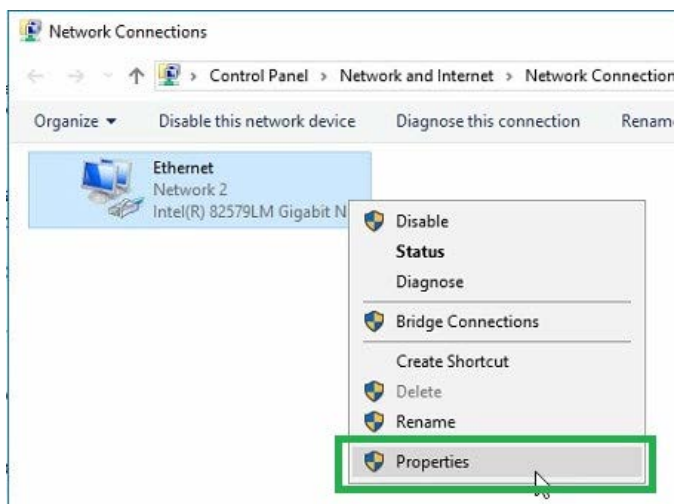

Select "Internet Protocol Version 4 (TCP/IPv5) and select "Properties".

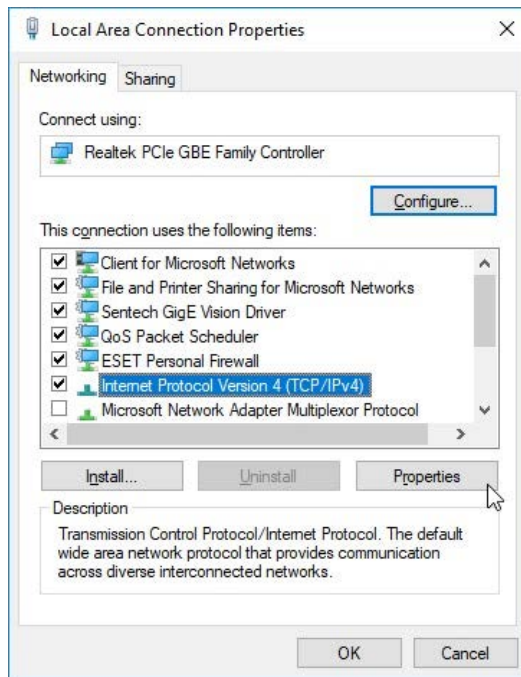

Select "Use the following IP address:" and enter 192.168.5.100 for the IP address and enter 255.255.255.0 for the Subnet mask.

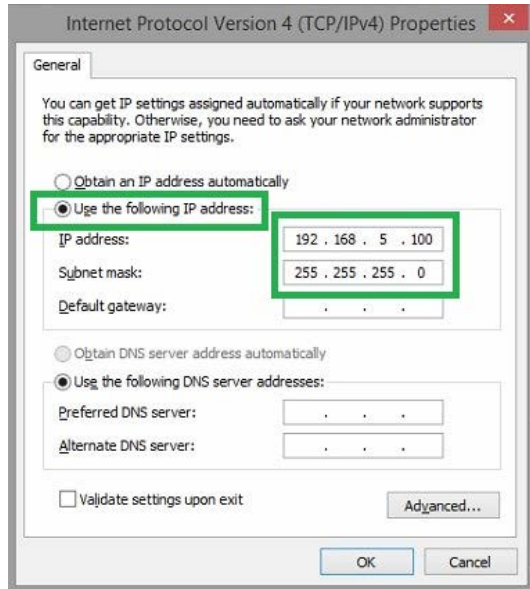

Select OK. The Windows network settings are the machine are now configured.

### 3.3.2 Network Connection

Connecting through an office network

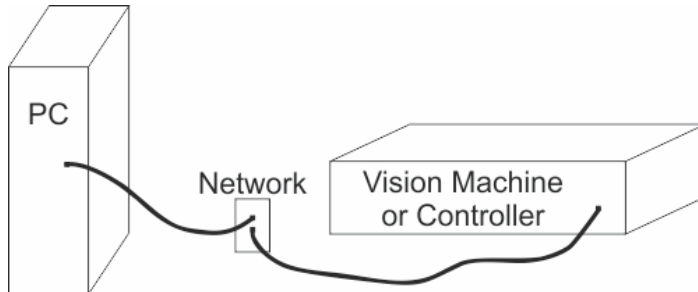

Once the machine is connected to the company network port, power the machine on. The power switch for the Express is located on the power supply box for the machine. Once the machine has initialized, the home screen will appear on the LCD screen.

Select the Settings Screen icon.

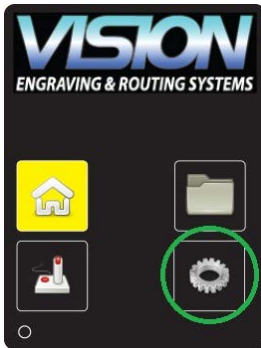

Select the Connectivity Screen icon.



Confirm that the LCD shows the Mode is set to DHCP.

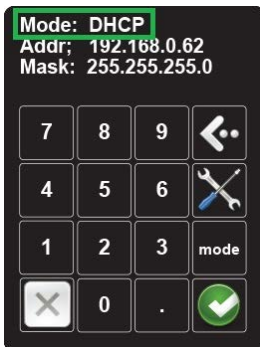

If the Mode displays Static, press the mode icon. This will change the Mode to display DHCP.

Make a note of the address that is displayed. This will be needed at a later step in the setup. NOTE: If an IP address is not displayed, check with your network administrator to confirm that your network is configured for DHCP.

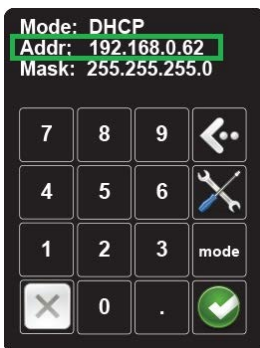

Press the green check mark button.

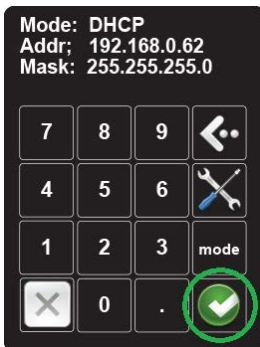

Press the X to exit the connection screen.

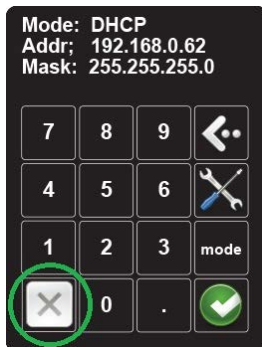

Press the X to return to the home screen.

Open the Vision 10 Software by selecting the Vision Expert 10, Vision Express 10 or Vision Pro 10 icon from the Windows desktop.

Go to the Engrave menu and select engraving defaults.

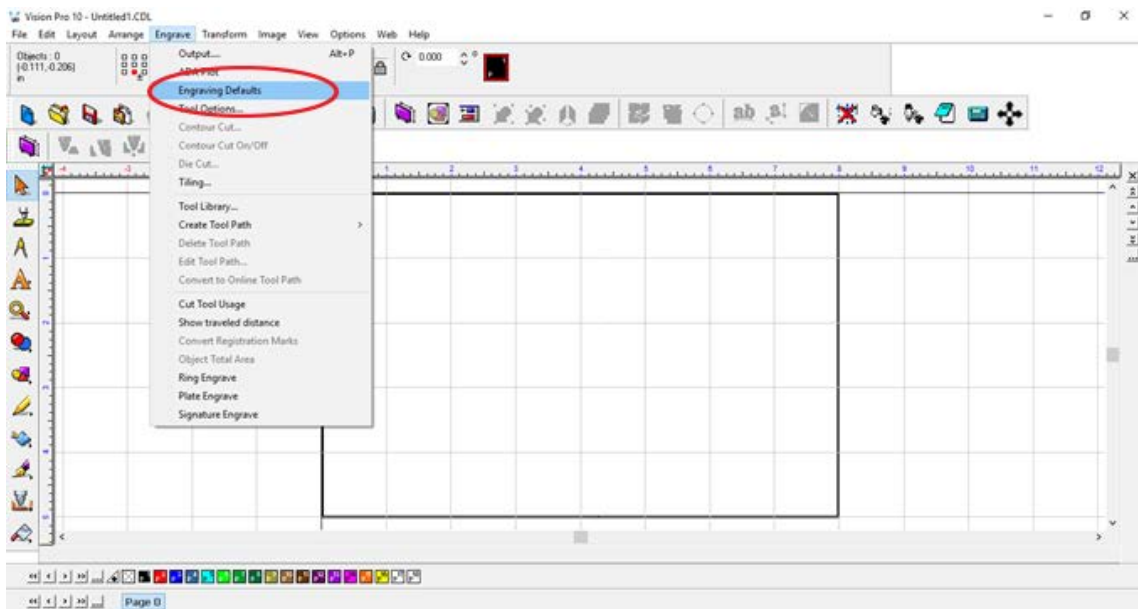

In the Engraving defaults window select the setup button.

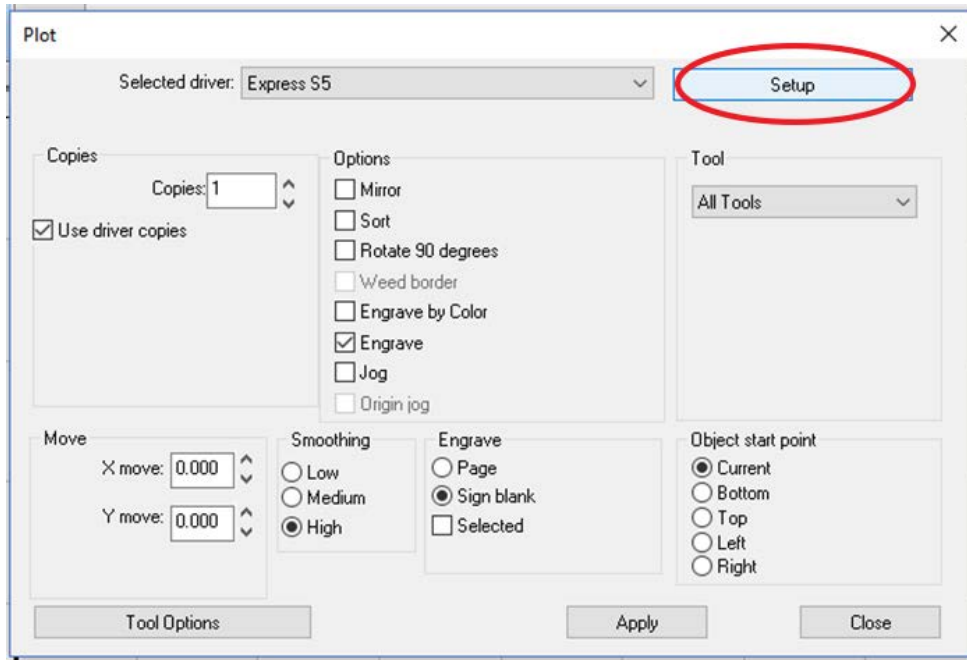

Select the port tab.

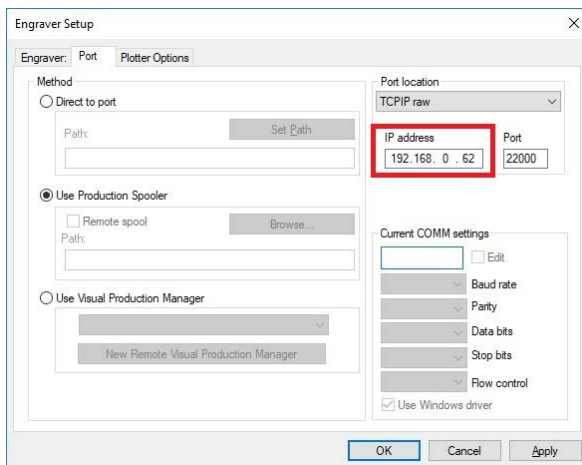

In the "IP address" box, enter the IP address that was displayed on the Vision Express in a previous step. You can see this address from the machine home screen by pressing settings icon and then the connectivity screen icon.

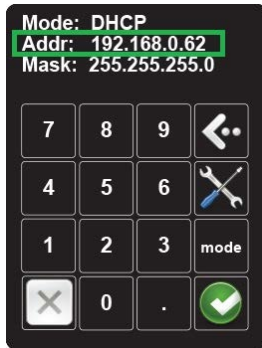

Verify that the method is set to "Use Production Spooler", the Port location is set to "TCPIP raw", and the port is set to "22000".

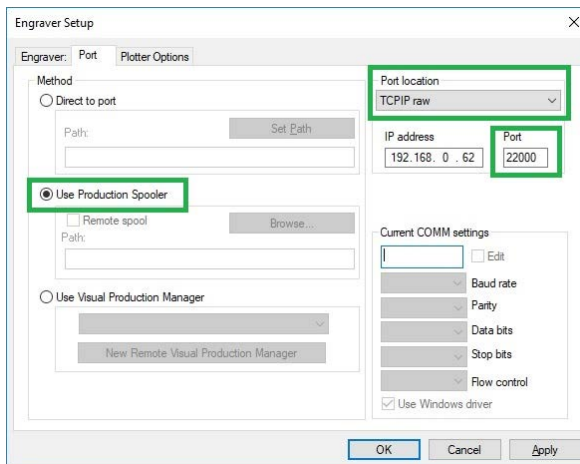

**IMPORTANT:** If more than one driver is installed, you must change the IP address in the port tab for all drivers.

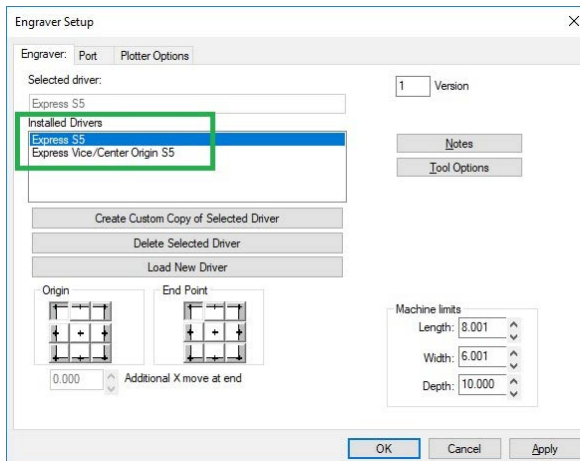



Next, press Apply and OK to save the settings.

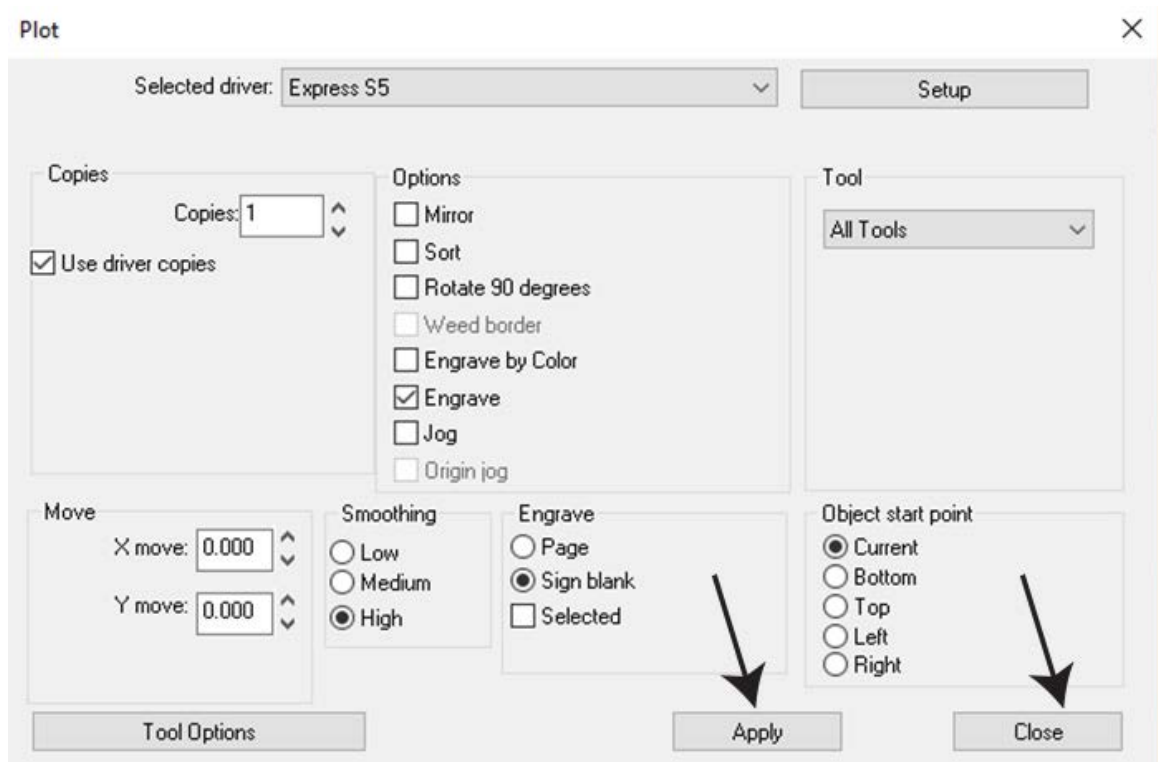

The machine and Vision software are now configured.

## 4 The Front Panel

### Home Screen

The home screen contains four buttons: Home Machine, Job Folder Screen, Jog/Offset Screen, and Settings Screen. The home screen also has a Data Receive light that is green when the machine is receiving data from the computer and blank all other times.

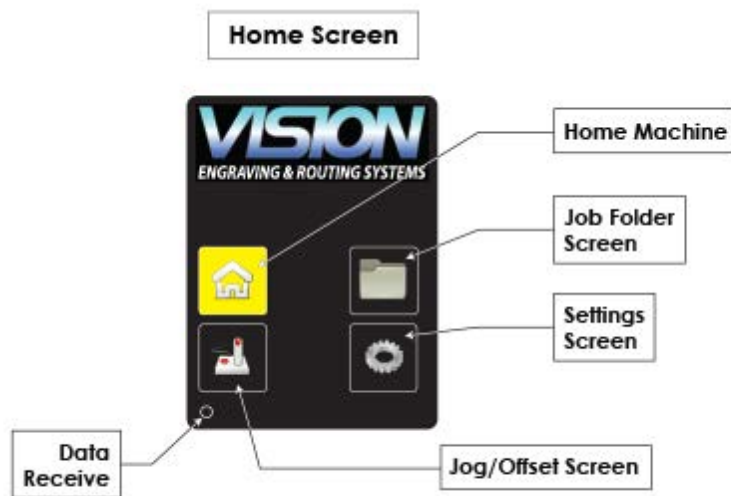

### Home Machine

Every time you power on the machine the Home Machine button will be Yellow. Press the Home Machine button to energize the motors, have the machine find the limit switches, and set the machine home location. After the initial home set the first press of the Home Machine button sends the spindle to the current offset and the second press sends the spindle to the machine home, checks the limit switches, and sets the current offset to home or offset number 1.

### Job Folder Screen

The Job Folder Screen contains five buttons. The up arrow moves the cursor up one position. The down arrow moves the cursor down one position. The green right arrow selects the file highlighted by the cursor. The trash can deletes the file highlighted by the cursor. The X button exits this screen and jumps to the screen above. Any jobs in the machine will be displayed under the Saved Jobs heading on the top left of the screen. If there are more jobs saved than fit on the screen you must use the up and down arrows to move to the desired job.

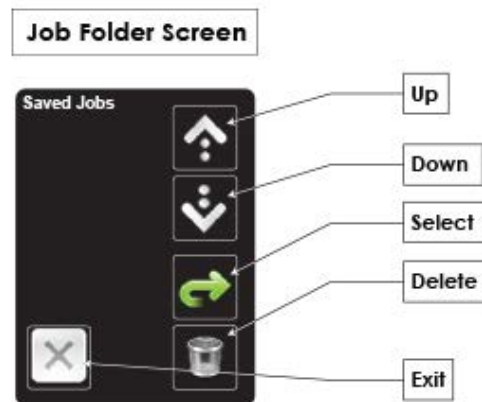

### Jog/Offset Screen

This screen displays the spindle location and allows manual control of the X, Y, and Z position. The user can set seven different offsets locations and set a surface for engraving when not using the proximity sensor. The display in the top left corner of the screen shows the current X, Y, and Z spindle location. The current X and Y offset location is displayed on the top right of the screen. The Jog/Offset screen has thirteen buttons that control various functions. The Offset Number button scrolls through all of the offset numbers. Pressing this button increases the offset number by one and goes from 1 to 9. The Preview button shows the outline of the current job and does nothing if there are no jobs in the machine. The X+, X-, Y+, Y- jog the X and Y axes in that direction. The Jog Speed button toggles the X and Y motion between slow, medium and fast. The Z+ and Z- arrows jog the Z axis up and down and are usually used to set the surface. The jog speed button has no effect on the Z jog speed as this is constant.

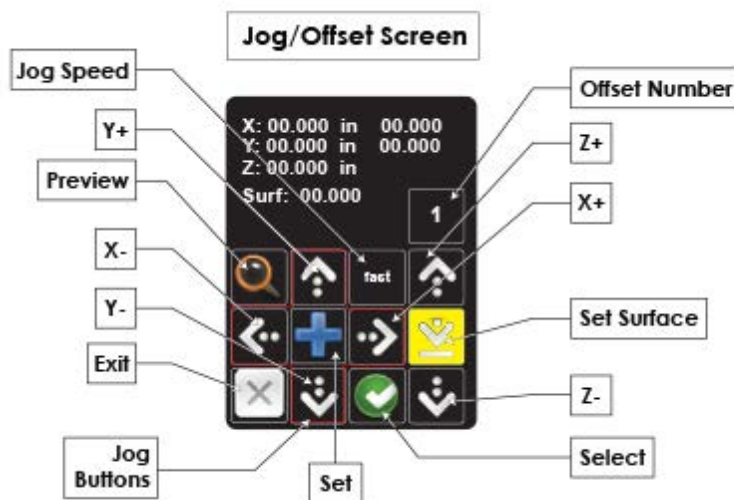

### Set Offset

To set an offset location press the offset number button until you reach the desired number. Offset number 1 is always reserved for the machine home (upper left corner 0,0,0) and can not be overwritten. Offset number 9 is reserved for the vise offset and can only be changed using the vise button on the tools screen as described later in this section. After selecting the desired offset number press the X and Y jog buttons to move the spindle to the desired location. With the spindle at the desired offset location, press the blue plus Set button to save this location under the offset number displayed on the screen. Pressing the green check button will always move the spindle to the offset location corresponding to the offset number displayed on the screen.

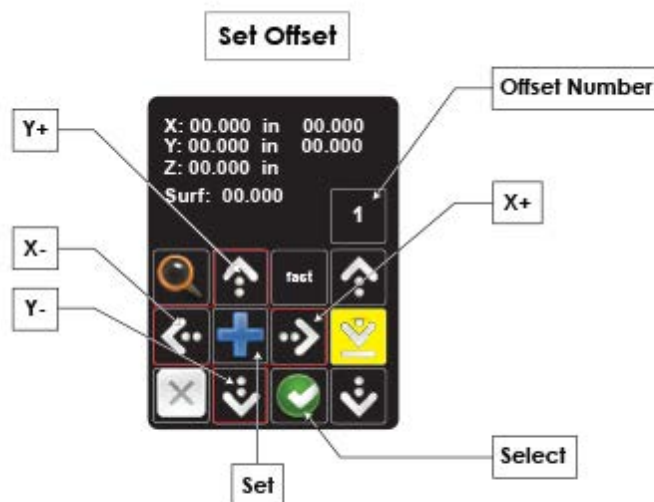

### Set Surface

Press the Z+ and Z- buttons and jog the spindle/cutter to the surface. Press the set surface button. Surface will now display the current Z axis location above the surface.

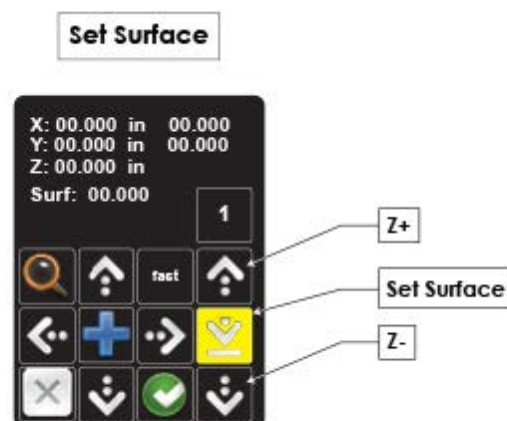

### Settings Screen

The Settings Screen contains four buttons: Connectivity Screen, Tools Screen, Go To Location Screen and Exit. This Settings screen also shows the machine Serial number.

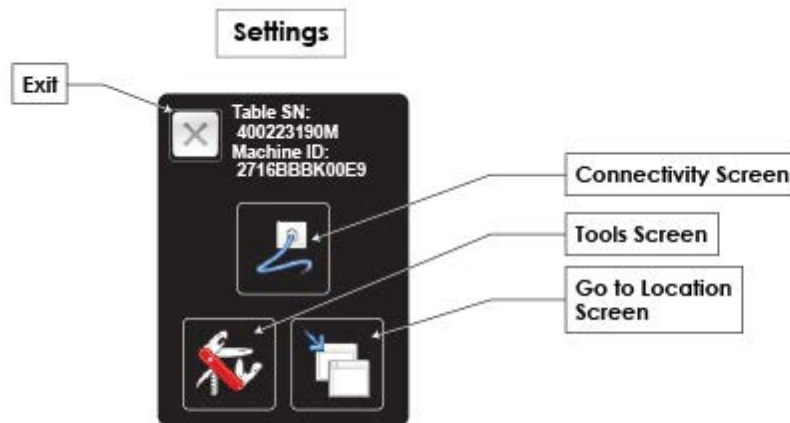

### Connectivity Screen

Mode: indicates if the machine is currently using a static IP address or using DHCP to obtain an IP address from the connected computer or network. Addr: shows the current IP address of the machine. Mask: shows the current Sub net Address of the machine. Change allows you to type in an IP and a sub net address when in the static mode. The mode button allows you to toggle between Static and DHCP. To set a static IP address press the mode button until static is displayed. Addr will be red then type in the full IP address including (.) and then hit the Enter button. The Mask may be red now and using the numbers type in the mask address and hit the enter button. The screen will say changing IP and then the Addr and Mask will be displayed.

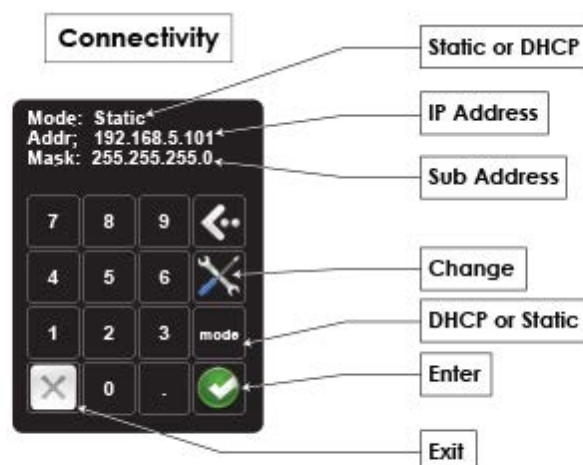

### Tools Screen

The Tools Screen contains ten buttons and one slider that is associated with the spindle button. The X button exits this screen and jumps to the screen above. The vise button is used to set the location of the center of a vise if used on this machine. The inch button toggles the screen units between inch and mm. The Laser Offset button is used to set the laser pointer offset on the machine at the factory. The Laser button turns the laser pointer on and off and will be Red when off and blank when on. The Aux 1 button is used to manually turn the Remote Vacuum Port On or Off and will be Red when off and blank when on.

Aux 2 and Aux 3 buttons are not used on the Express S5 machine. The Fan button turns the cooling fan On or Off and will be Red when off and blank when on. The Spin button turns the Spindle On or Off and works in conjunction with the slider next to it which sets the Spindle RPM's. This screen is used to test or troubleshoot these functions of the machine.

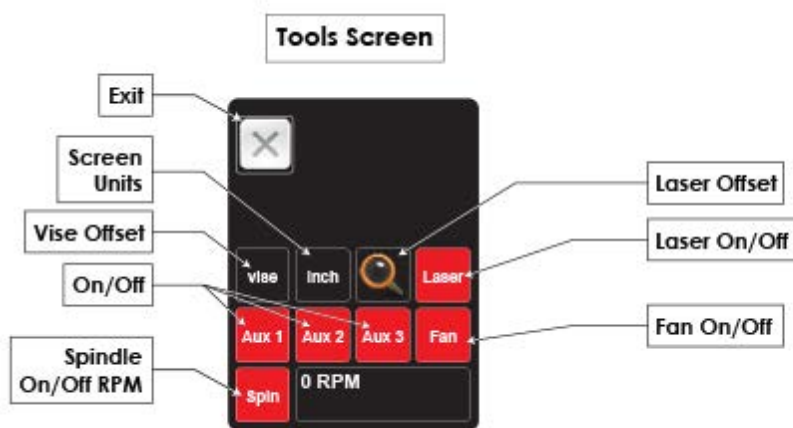

### Vise

The vise button is used to set the center location of a self centering vise. Place the vise on the t-slot table and secure it with the supplied t-nuts. In the tools screen press the vise button and the vise location screen will appear. Press the X and Y jog buttons on this screen until the laser pointer is in the center of the vise. Press the green check mark (select) button and the vise offset is now set.

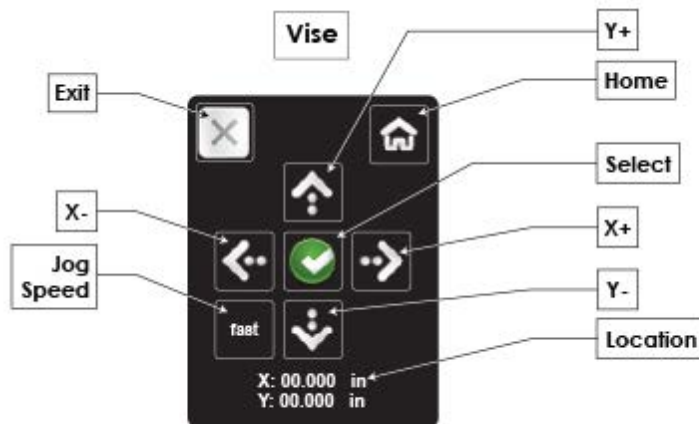

### Go to Location Screen

The Go to Location screen is used to move the spindle to a specific location on the engraving area. Press the X button and the X display will turn red. Then type in the location using the number pad. Press the Y button and type in the location using the number pad. Then press the green check mark. The spindle will move to that exact location.

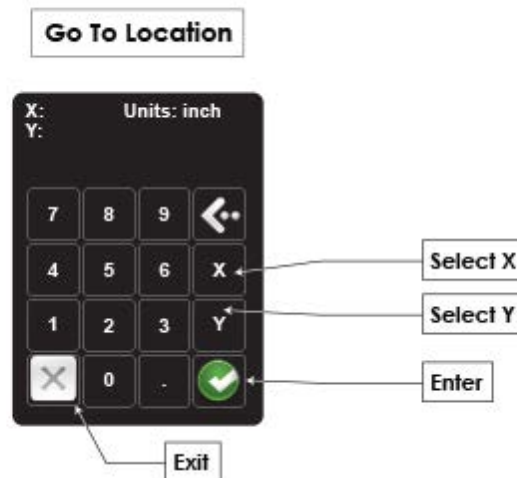

### Measure Feature

Press plate size, then measure in Vision software. The machine goes into measure mode, the laser pointer turns on, and the machine screen will change to the Measure screen shown below. Using the X and Y jog buttons on this screen, jog the laser pointer to the top left corner of the desired engraving area and press the green check (select) mark. Using the same X and Y jog keys, jog the laser pointer to the bottom right corner of the desired engraving area and press the green (select) check mark. The software automatically creates a plate size in this bounding area.

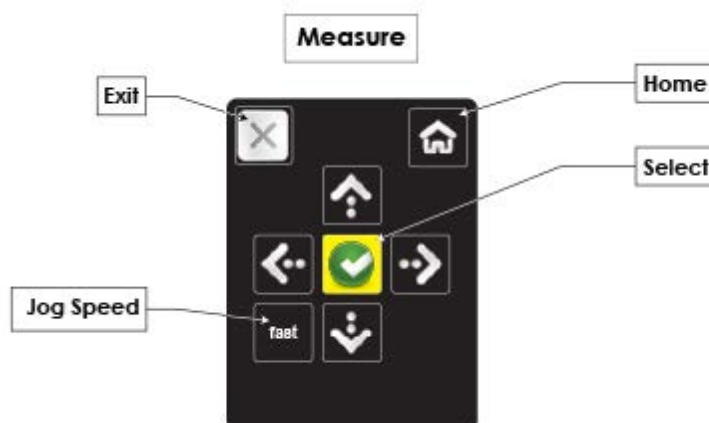

**Emergency Stop Screen**

When the Emergency button is activated on the machine the Emergency Stop Screen will appear on the Front Panel and not allow the operator to do anything on the machine until the Emergency stop is deactivated. Check to make sure whatever caused the Emergency Stop button to be activated has been cleared or repaired and then twist the button until it "pops up" to clear the Emergency Stop.

**E-Stop**



## 5 Step by Step Operation

### 5.1 Holding Down Material

There are many ways to hold material down on the t-slot table. One of the easiest things to do is to place the material in the upper left corner of the t-slot table. This will ensure that the engraving is in the correct position on your material. You can use double-sided tape, Multi Mat hold down material, or the quick lock vise to hold down material to the t-slot table. Double-sided tape or Multi Mat material are available from your Vision Distributor or directly from Vision. The quick lock vise is an optional accessory for the Vision Express - see the Optional Accessories section for details.

#### Hold Down Techniques

Holding material in place is critical for engraving and cutting applications. The Multi Mat material is useful for both applications, but using double-sided tape or a spray adhesive can be a better choice for some applications. For most materials and engraving applications, the Multi Mat material is the easiest to use. Simply place it on the table and place the material to be engraved on top of it. When cutting completely through, or kiss-cutting materials, care must be taken to not cut too far through the material, or the Multi Mat will be slightly cut in the process. The most common approach to cutting when using the Multi Mat is to set the cut depth using the machine's micrometer or the "stacked material method" as described below and in the section on Profile Cutting. When using the micrometer, the material thickness should be measured with calipers. Keep in mind that some materials can vary in thickness and there may be areas that remain uncut. For a detailed explanation on the use of the micrometer for setting cutting depth, see Example Job 4 in the Profile Cutting section.

#### Using Sacrificial Material

Many times, double sided tape can be a quick and very secure way to hold material down the the t-slot table. The downside to using tape is that it will remain on the table and can be a problem to remove. A better solution is to place Multi Mat material on the t-slot table, then place a piece of sacrificial material (of the same type as being cut) on top of the Multi Mat. Then apply double-sided tape to the sacrificial material and place the material to be cut on top of the sacrificial material. In this manner, while the machine is engraving or cutting other jobs, the sacrificial material/cut material can be removed and separated by the user, making better use of machine time and allowing for easier clean up. Note - if double-sided tape is used, be careful to cover a sufficient area to keep the material in place and also to hold smaller pieces in place so they to not move when the last section of the small piece is cut.

#### Spray Adhesives

Using a spray adhesive, in conjunction with "transfer tape" or "application tape" is yet another method often used. As with the other methods, place Multi Mat on the t-slot table, A piece of sacrificial material is then covered with transfer tape on its top surface and a spray adhesive is applied on top of the tape. Place the sacrificial material with the tape/adhesive side facing up on the Mutli Mat material. Then, the material to be cut should have transfer tape applied to its back side and adhesive is sprayed on to the transfer tape. Place the material to be cut, tape/adhesive side down, on to the sacrificial material. This is a very secure way to cut through materials and once cutting is finished, the tape/adhesive can be easily removed from the back sides of cut pieces.

**Edge Guides:** The t-slot table edge guides need to be adjusted to the thickness of material that you are engraving. If they are not adjusted properly, the machine may not engrave characters completely.

#### Edge Guides (Side View)

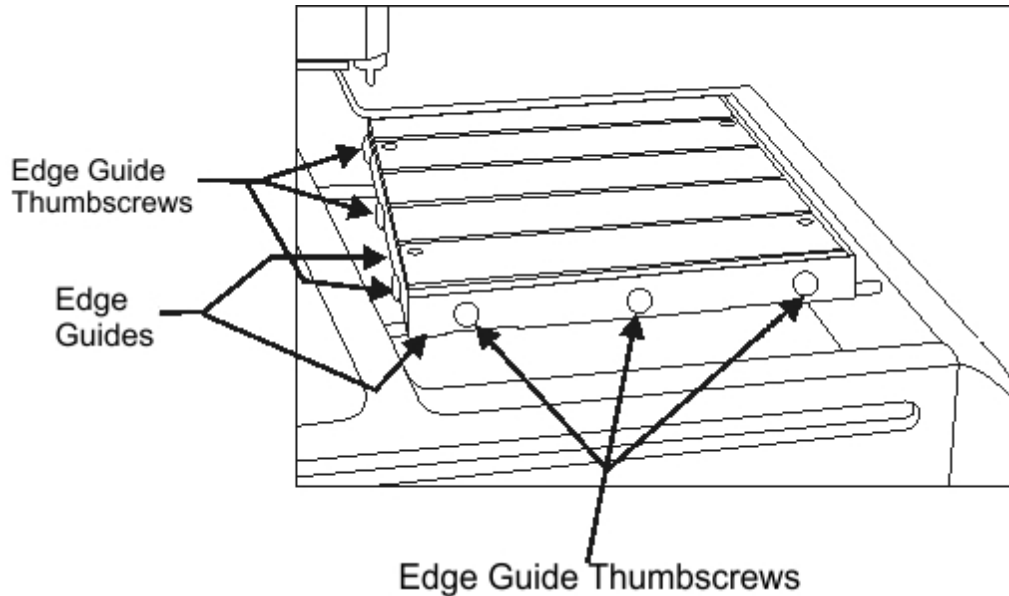

To adjust the edge guides, loosen the edge guide thumbscrews and raise the edge guides to their top position, then lightly tighten the thumbscrews. Slide the material you would like to engrave up against the top and left sides of the t-slot table - the edge guides will stop the material. Loosen the edge guide thumbscrews and lower the edge guides until they are even with the material surface, or just below the material surface. Tighten the edge guide thumbscrews. This process should be repeated anytime materials of different thicknesses are to be engraved. On thicker materials, more than 0.10 inch (2.5 mm), the edge guides can remain in their uppermost position.

## 5.2 Zeroing the Cutter

### Zeroing Cutters

(Refer to the diagram on the following page)

### Zeroing Cutters for Top-Loaded Spindles

1. Turn the micrometer to zero. This provides a starting point and reference for setting the depth accurately. It's important to note that the micrometer should be threaded onto the spindle housing sufficiently to prevent excessive play in the micrometer and nosecone. If there are too few threads holding the micrometer in place it will move during the engraving process. The best starting position is 3 or 4 complete revolutions from the top.
2. With the appropriate cutter installed in the spindle, loosen the setscrew in the brass cutter knob with a spline wrench (commonly referred to as the cutter wrench). CAUTION: When you loosen the setscrew in this step, the cutter may easily fall out of the spindle and can cause cutter tip damage. Use one hand to hold the cutter before loosening.
3. Gently place a piece of metal against the bottom of the nosecone so as to push the cutter even with the bottom of the nosecone. Now the cutter should be flush with the nosecone.
4. Tighten the cutter knob setscrew. Your cutter is now "zero'ed". Rotating the micrometer to the right will increase the depth of the cut. Each click of the micrometer = .001". A full revolution is .025".

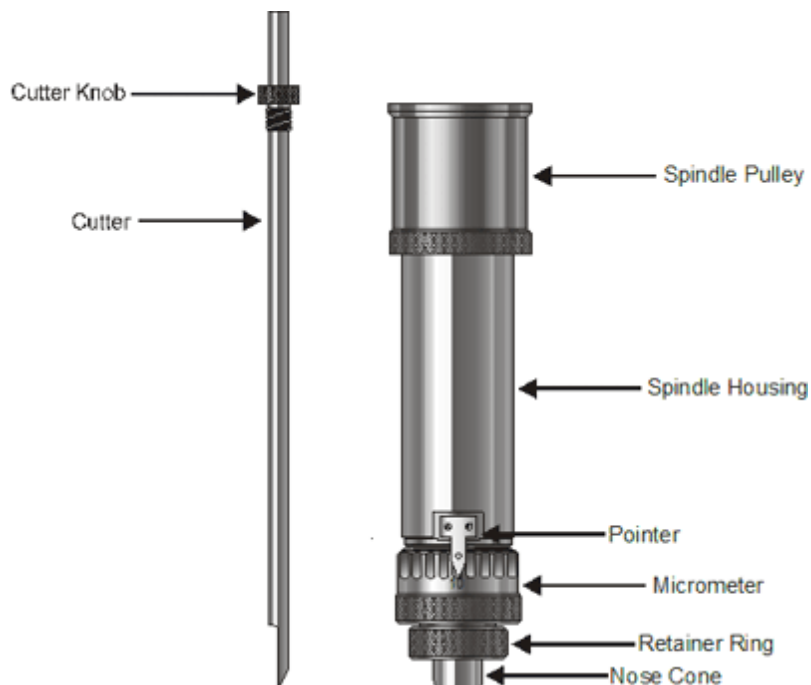

## 5.3 Proximity Sensor

### Advantage of this Feature

The advantage of this device is that it eliminates the need to perform a surface setting procedure. It is used when utilizing a nose cone or diamond drag cutter. It cannot be used without a nose cone, such as when burnishing or setting multiple pass depths in the software.

### Procedure

1. Make sure that the proximity switch is turned on within the Vision software. Ensure that some travel is allowed to “float” the spindle on the pressure spring. The pressure spring adjuster must be backed off.
2. Zero the cutter in the spindle and dial in the desired depth on the nose cone micrometer.
3. Send the job to the controller via the computer.
4. Press the “Start” button on the touch screen.

### Usage

#### “Nose-riding” - WITH proximity sensor

Engraving with the proximity sensor can only be performed with a nose cone attached, or when diamond drag engraving.

#### “Non-nose-riding” - WITHOUT proximity sensor

When setting a depth in the Vision software, the proximity sensor should be turned off in the Cut Toolbox (in the Vision software program before sending the job to the machine). Also, make sure that there is no “float” on the spindle by locking the pressure spring adjuster all the way down. Locking the spindle is especially important when engraving into hard surfaces or materials like brass and stainless steel.

### Diamond Drag Engraving

To install a diamond drag adapter, remove the retainer ring and nose cone from the bottom of the spindle and replace with the diamond drag adapter. For diamond drag engraving, the engraving motor is turned off and the cutter “drags” across the material. Down pressure against the material can be reduced or increased as necessary by following the steps in ["Adjusting Spindle Pressure"](#)<sup>[116]</sup> section of this manual.



## 5.4 Step by Step Operation

In the following sections, there are 4 example jobs the user can use to learn the different ways to use the Vision Express. In the first section, the machine will be set up to perform a diamond drag operation on coated aluminum and a simple plate will be engraved. In the second example, engravers plastic will be rotary engraved to make a small sign. The third example is a coated brass burnishing operation which will cover the importing of text variables for multi-plate engraving. In the last example job, a set of name badges will be engraved and cut out of engravers plastic.

The sections and example jobs are designed to incrementally teach the user how to use the machine, as well as use some of the common functions within the Vision software. It is recommended that the first time user read through and practice the techniques in these example files in the sequence they are provided in this manual.

### 5.4.1 Diamond Drag Engraving

#### Engraving - Non Rotating

In this section, we will set up to engrave with a non-rotating cutter, such as a diamond drag cutter. The figure below shows the Vision Express spindle with a diamond drag cutter.

#### The Vision Express spindle with diamond drag cutter

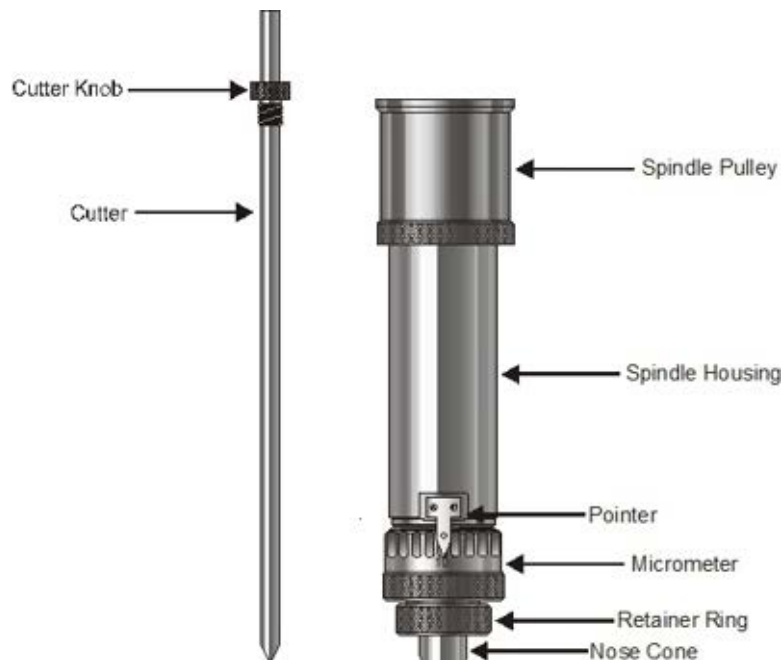

First, to install the diamond drag cutter, loosen the set screw on the cutter knob with the supplied cutter wrench and move the cutter knob to about the mid-point of the cutter tool, then lightly tighten the set screw. (Note that the set screw on the cutter knob is NOT a standard Allen screw. It is a Spline Wrench. DO NOT attempt to turn the set screw with any tool other than the cutter wrench). Insert the cutter into the top of spindle and lower it until the cutter knob can be screwed into the spindle. The cutter knob is REVERSE threaded, so in order to tighten the cutter knob, turn the knob COUNTERCLOCKWISE (when viewed from the top of the spindle) until it is hand tight.

With your finger at the bottom of the nose cone, loosen the cutter knob set screw and lower the cutter so that the cutting tip extends below the bottom of the nose cone by approximately 1/4 inch (6 mm). Then tighten the cutter knob set screw.

Power the engraver on by pressing the power switch. The line (-) on the switch will be pressed in. Set up the job you would like to engrave in the Vision Software (for an example job, please refer to the following section). Place the material on the t-slot table as described in the previous section. There is no need to adjust the Z-Axis height of the machine (also known as Set Surface). In this type of engraving, the Proximity Sensor will automatically sense when the cutter tip contacts the material and will adjust the Z-Axis height and cutting pressure. Also, the spindle does not need to rotate. The material selection (shown in the next section) will preset the engraver to turn the spindle rotation off and turn the proximity sensor on.

#### 5.4.1.1 Example Job 1 - Diamond Drag

In this first example, Diamond Drag engraving will be performed on a 3" x 2" plate. The material used for this example application is black painted aluminum.

Starting with a new file in Vision software, the first step is to adjust the plate size to match the plate to be engraved.

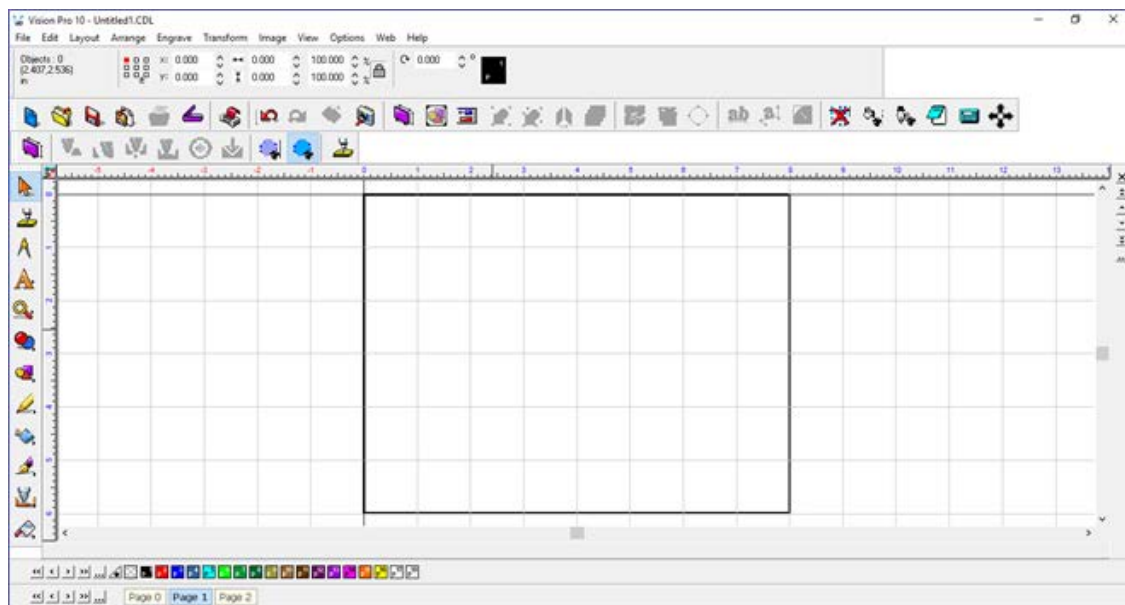

Click on the Plate Size icon.

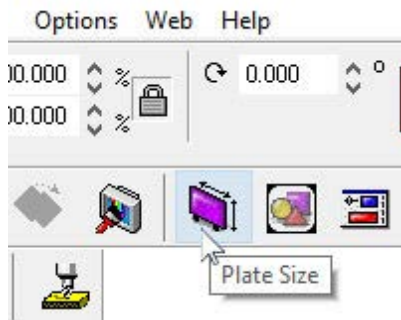

The Plate Size window will appear with either the last plate size used, or the default size for the Vision Express engraver.

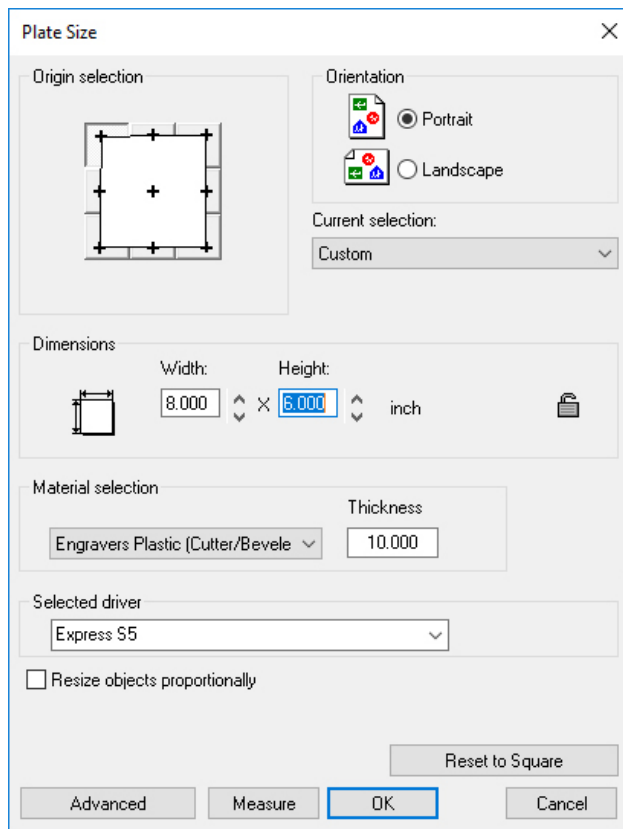

Click on the Current Selection drop down list and select Custom.

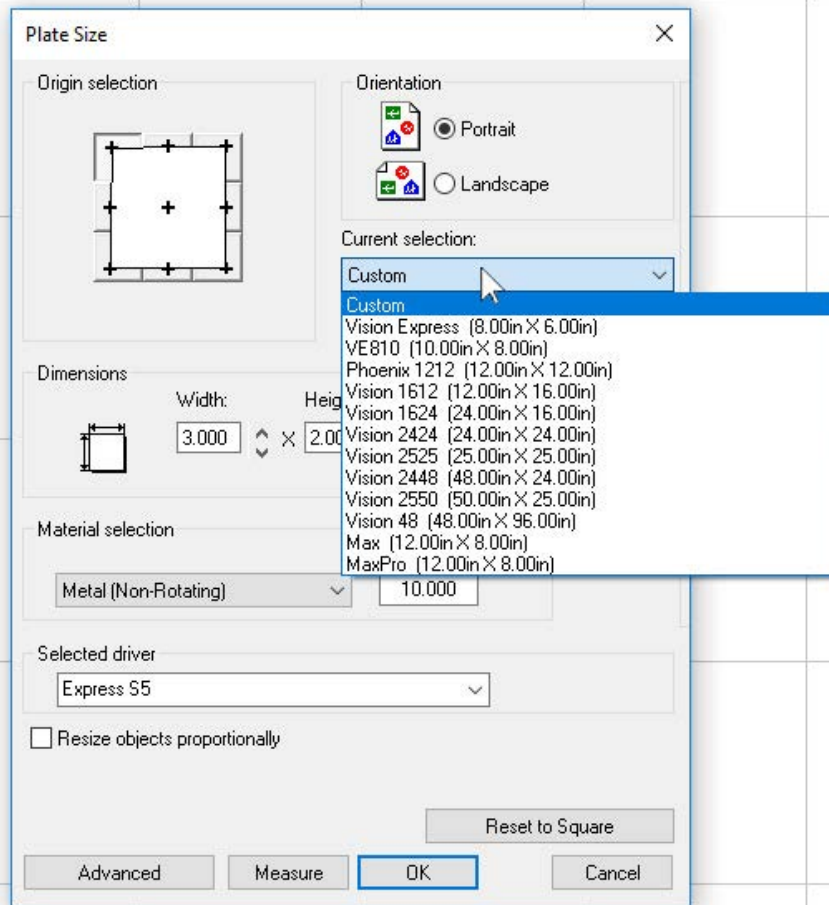



Enter the plate size to be engraved - for this example 3" x 2".

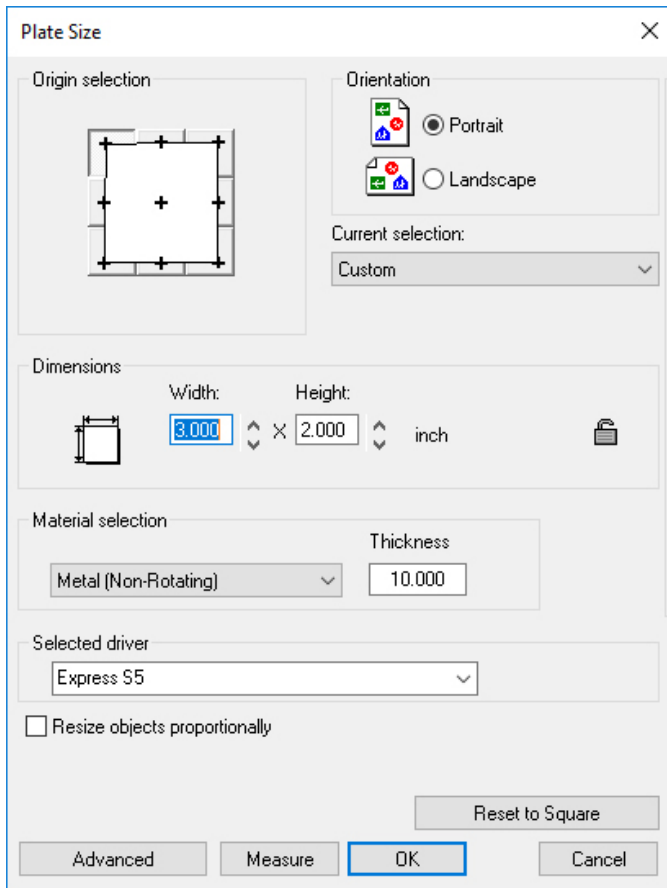

The image shows a software dialog box titled "Plate Size" with a close button (X) in the top right corner. The dialog is organized into several sections:

- Origin selection:** A diagram of a square plate with a central crosshair and eight small squares at the corners, indicating the origin and corners.
- Orientation:** Two radio buttons for "Portrait" (selected) and "Landscape". Below them is a dropdown menu labeled "Current selection:" with "Custom" selected.
- Dimensions:** A diagram of a rectangle with dimension lines. The "Width:" field contains "3.000" and the "Height:" field contains "2.000". The unit "inch" is shown to the right. A lock icon is present.
- Material selection:** A dropdown menu showing "Metal (Non-Rotating)" and a "Thickness" field containing "10.000".
- Selected driver:** A dropdown menu showing "Express S5".
- Resize objects proportionally:** An unchecked checkbox.
- Buttons:** "Advanced", "Measure", "OK" (highlighted with a blue border), "Reset to Square", and "Cancel".

To add text, click on the Text Tools icon.

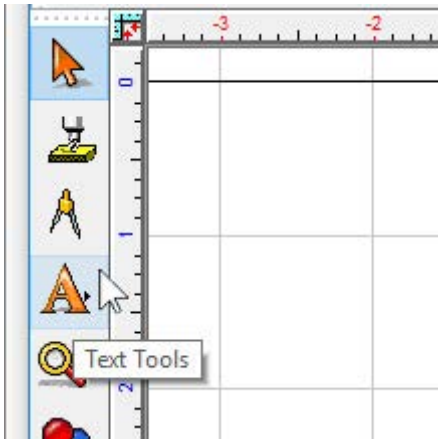

The flyout icons will appear, then select the Text Compose icon.

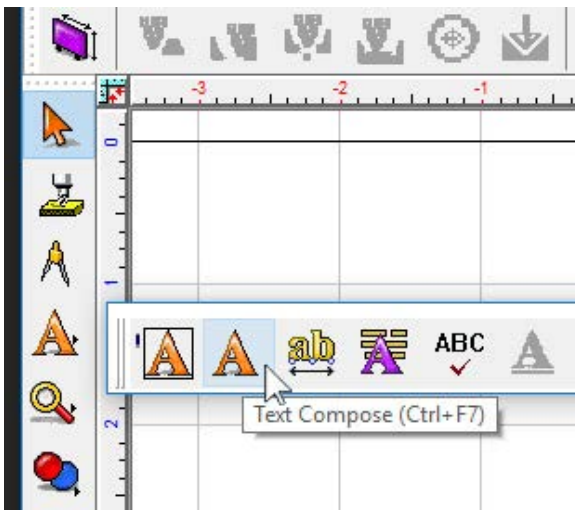

Click somewhere in the drawing to begin typing text. Note that on the top toolbar, the various font editing fields have appeared. The user should become familiar with the various ways fonts can be formatted with the toolbar options. For this example, the only change was for the font height, which was set to 0.500".

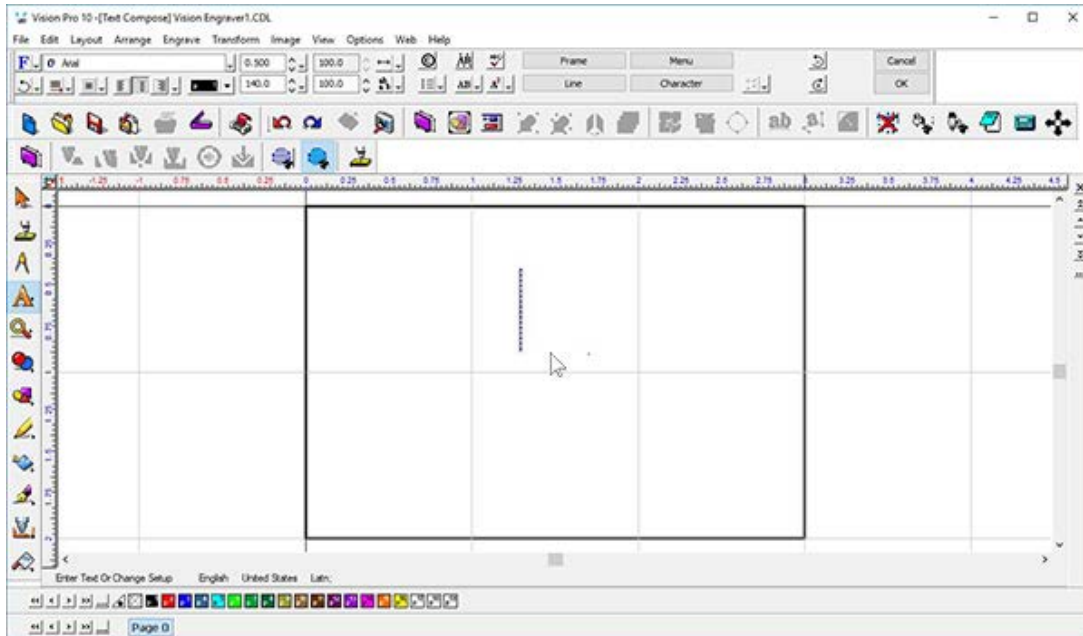

Begin typing text to be engraved.

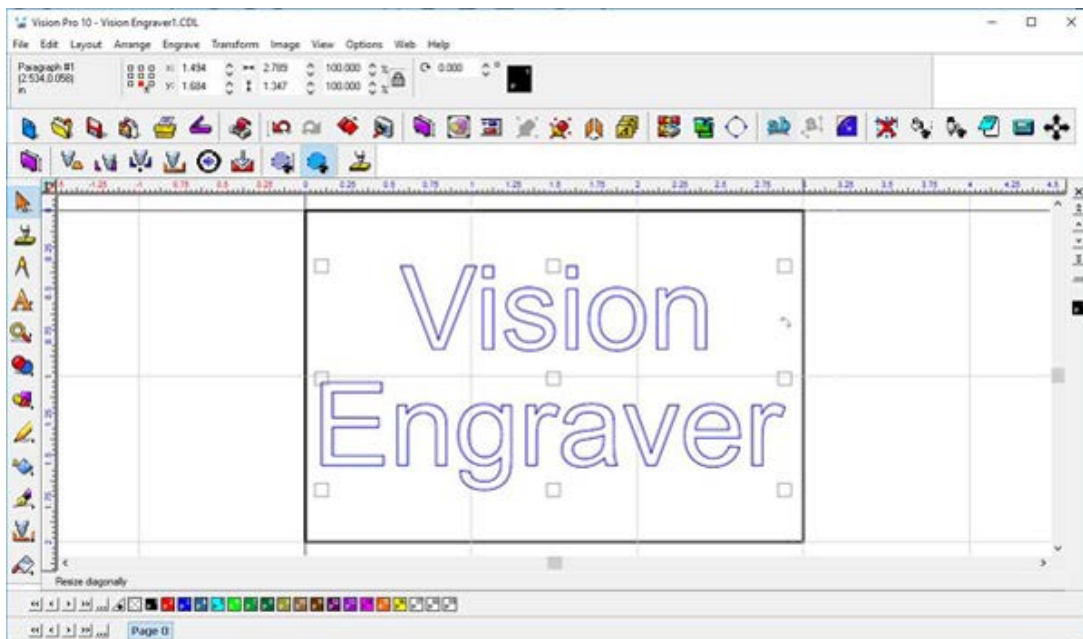

In order to align the text to the center of the plate, select **Layout** → **Arrange and Distribute** → **Align to Sign Blank** → **Center** (as shown below) from the top toolbar. Note that there are several ways to align objects within the Vision software.

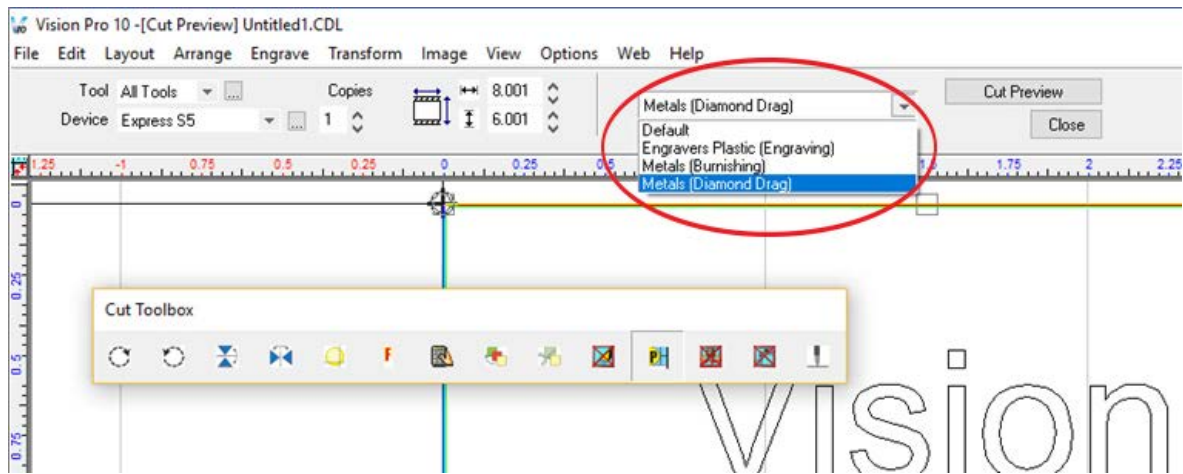

The Break Text warning may appear. If so, select No. If Yes is chosen, and more than one line of text has been entered, each line will align on top of one another in the center of the plate.

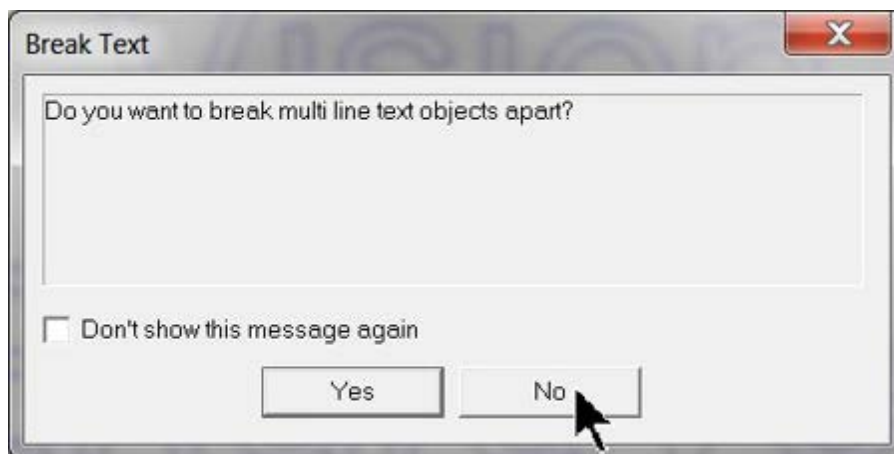

At this point, the screen should appear as below.

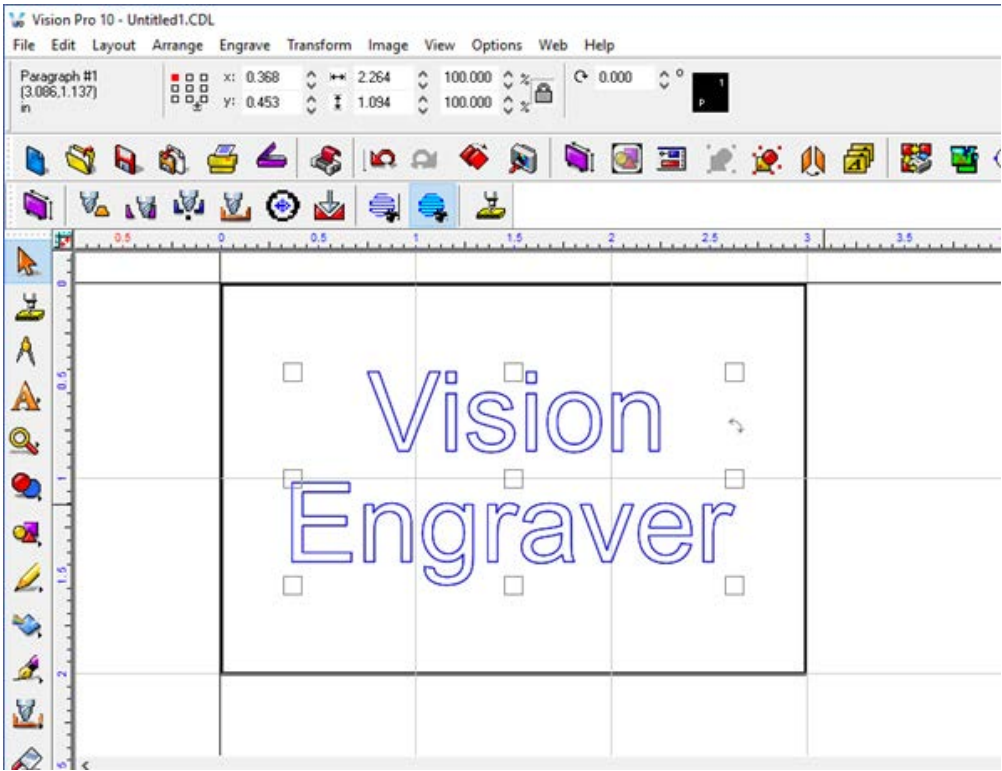

Next, the material should be placed on the engraving table, with the upper left corner of the material positioned in the home position (upper left corner of the engraving table). Note that the Multi Mat material has been placed on the t-slot table in order to hold the engraving material in place.

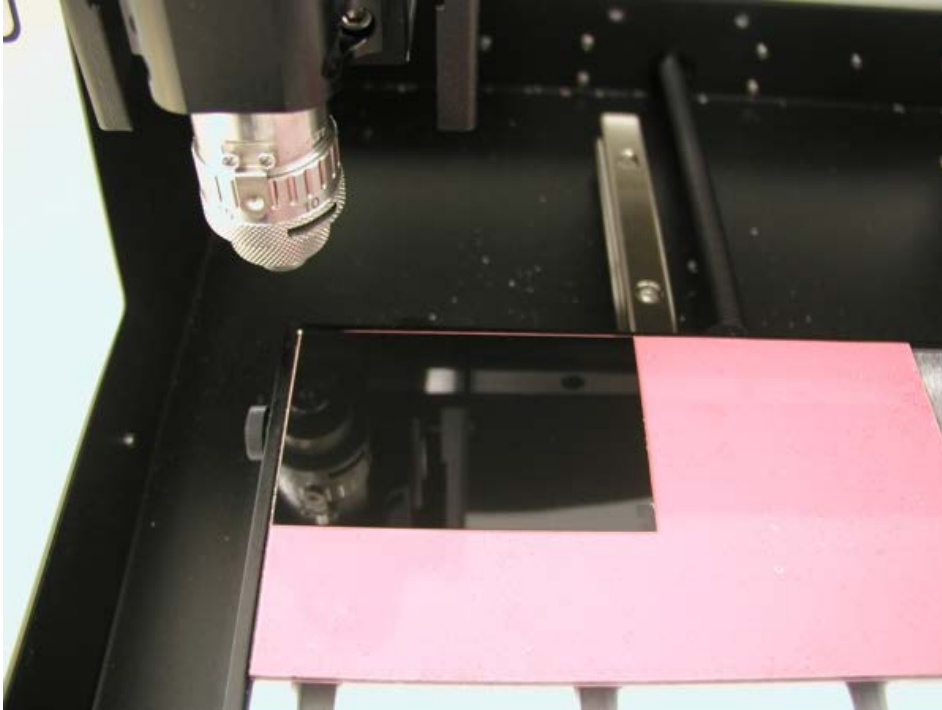

Select the Engrave icon from the left toolbar.

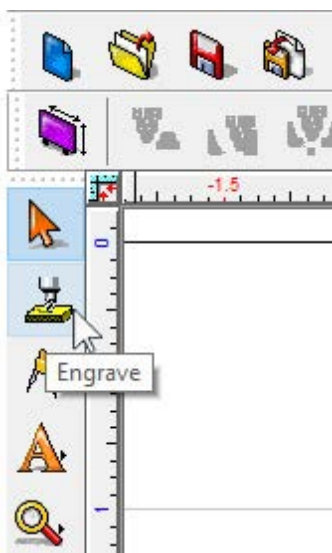

The Cut Toolbox will appear and the options for engraving will appear on the top toolbar. Make sure the Device selected is for your machine, then select the material drop down.

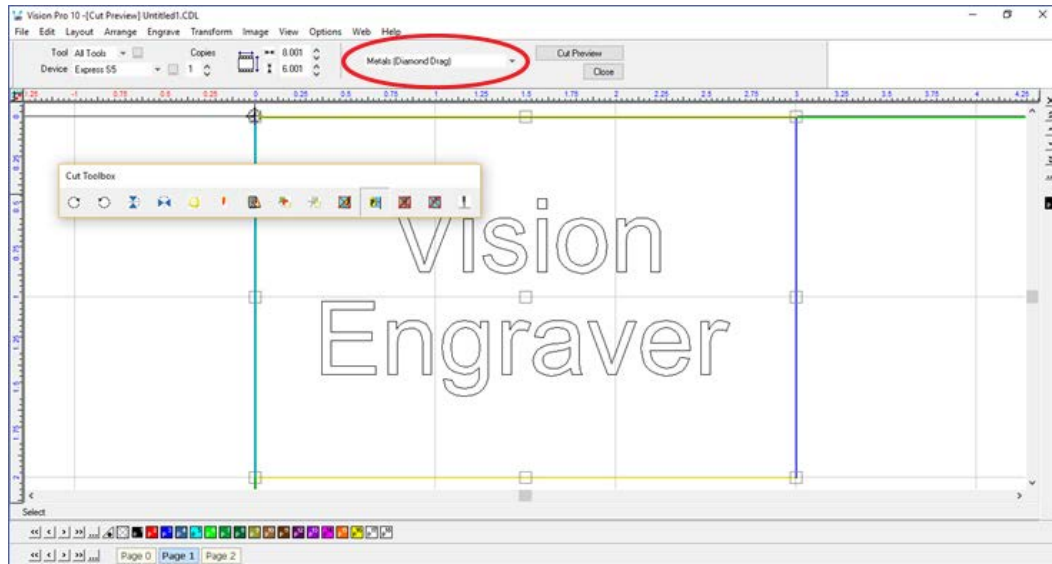

Select Metals (Diamond Drag).

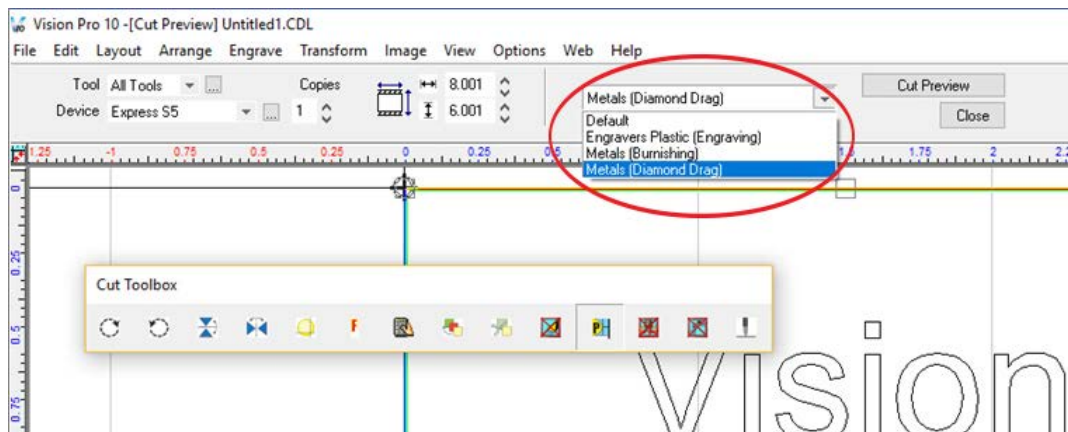

Press the Engrave button in the cut toolbox to send the job to the machine.

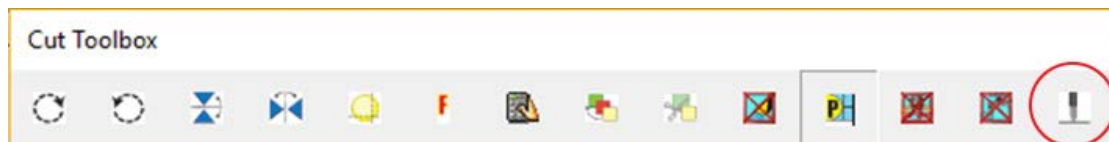

We want to first perform a dry run to verify we will be engraving in the correct area. On the machine press the magnifying glass to use the laser feature to outline a box around the area we will be engraving.

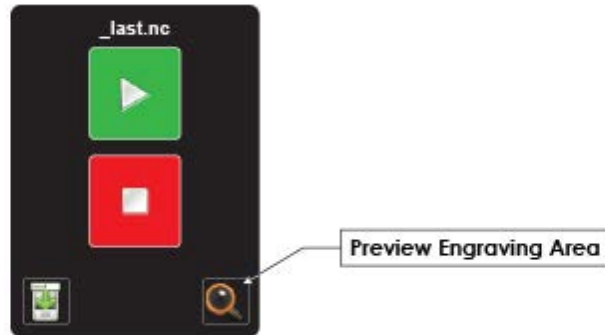

**NOTE:** Dry Run Operation - There is an offset between the spindle and the red laser pointer of approximately 0.38 inches (9.6 mm) in the X and 0.44 inches (11.2 mm) in the Y directions. Therefore, if the characters to be engraved extend beyond 7.56 inches (192 mm) X (to the right) and 5.62 inches (142.7 mm) Y (toward the bottom) of the machine's home position, the file will not run because the spindle would have to move beyond its limits.

When ready to engrave press the green play button on the touchscreen.

**NOTE:** keep hands and other loose objects away from the engraver during operation.

Press the Start Button on the engraver to begin the Dry Run. The Dry Run feature will automatically activate the red dot laser pointer and show the user where the machine will engrave.

**NOTE:** If the spindle turns, or begins to drop toward the material, either press the Pause Button or the Emergency Stop Button on the engraver. If either of these occur, make sure that Dry Run was selected in the Cut Toolbox (shown as the letter "D") and that the spindle has not been turned on. The Spindle icon on the Cut Toolbox is show below for reference.

If the file and material appear to be positioned properly and you are ready to engrave, select the Engrave icon from the left toolbar, turn off the Dry Run option and check to make sure the Proximity.



The finished piece should appear as shown below.



## 5.4.2 Rotary Engraving

In this section, we will set up to engrave with a rotating cutter. The figure below shows the Vision Express spindle with a rotary cutter.

NOTE: It is recommended to use a vacuum chip removal system which removes the debris while engraving.

### Vision Express Spindle with Rotary Cutter

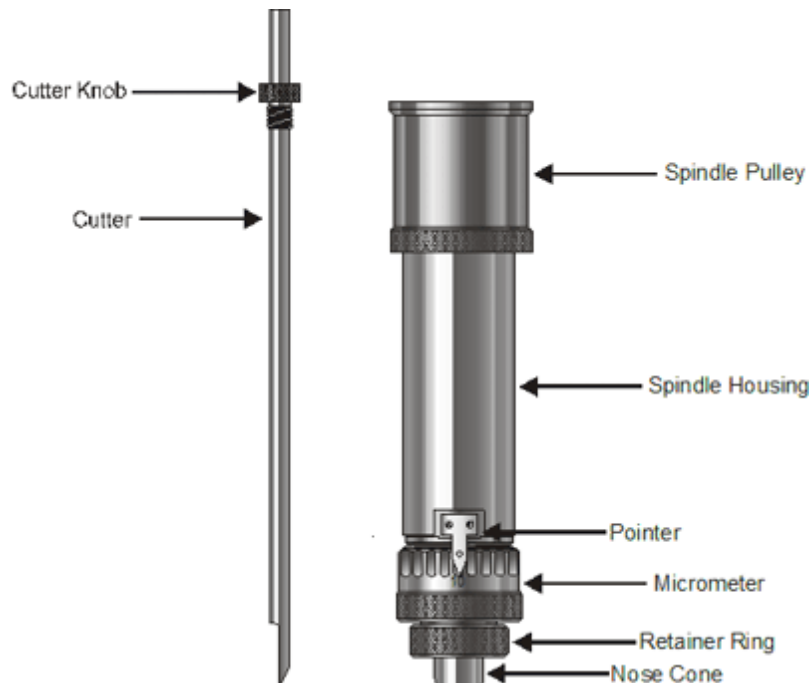

First, to install the rotating cutter, loosen the set screw on the cutter knob with the supplied cutter wrench and move the cutter knob to about the mid-point of the cutter tool, then lightly tighten the set screw. (Note that the set screw on the cutter knob is NOT a standard Allen screw. It is a Spline wrench. DO NOT attempt to turn the set screw with any tool other than the cutter wrench).

Insert the cutter into the top of spindle and lower it until the cutter knob can be screwed into the spindle. The cutter knob is REVERSE threaded, so in order to tighten the cutter knob, turn the knob COUNTERCLOCKWISE (when viewed from the top of the spindle) until it is hand tight.

Then, you must zero the cutter. To do this, you must first turn the micrometer so that the pointer points to 0. Note - it is helpful to first turn the micrometer to the left (clockwise) until threads just start to appear on the spindle. This will be about 3 - 4 full turns of the micrometer from its uppermost position. This allows for sufficient depth adjustment when turning the micrometer to the right.

Take a scrap piece of material and push it up underneath the nose cone and hold it there. Loosen the cutter knob set screw and push the cutter down until it just touches the material. Tighten the cutter knob set screw. The cutter is now zeroed.

To run a job, set up the job in the Vision Software. (For more information on this, see the Vision Engraving Software manual and the example job file in the next section). Put the material on the t-slot table as described in the previous section.

### Adjusting Depth of Cut

Cutting depth depends on the type of material being engraved. Generally, manufacturers of engraving plastic provide recommendations for cut depth. If a recommended depth is unavailable, trial and error can be used to find the appropriate cut depth.

Since the depth is set to zero at this time, in order to increase cut depth, the micrometer at the bottom of the spindle should be rotated to the right (counterclockwise when viewing from the top of the spindle). To set a depth of 0.010 inches (0.25 mm) turn the micrometer to the right 10 clicks. Each "click" of the micrometer is 0.001 inches (0.025 mm).

Run a job with an initial setting of 0.005 - 0.010 inches (0.12 - 0.25 mm). After the job has run for a short time, press the Pause Button on the front panel, then adjust the micrometer for more or less depth, depending on the whether the engraving is acceptable.

Note - be careful not to set the depth of cut greater than the material thickness. This will cut completely through the material and potentially cut into the t-slot table.

For a detailed example of running an rotary engraving job, please see the following section.

#### 5.4.2.1 Example Job 2 - Rotary Engraving

In this example, a sign will be made using engraver's plastic. The piece is pre-cut and measures 4 inches x 6 inches (100 x 150 mm).

Note - In this application, it is highly recommended to use the Vacuum Chip Removal System as described in the Optional Accessories section. The process of engraving or cutting plastics, acrylics, sign foam and wood, produces a significant amount of debris that can clog the nose cone and/or get trapped between the nose cone and the material, which will cause engraving/cutting depth inconsistencies as well as potentially scratch the surface of the material. The Vacuum Chip Removal System significantly reduces these problems and provides for a cleaner work area.

As with Example Job 1, the first step is to set the plate size in the Vision software.

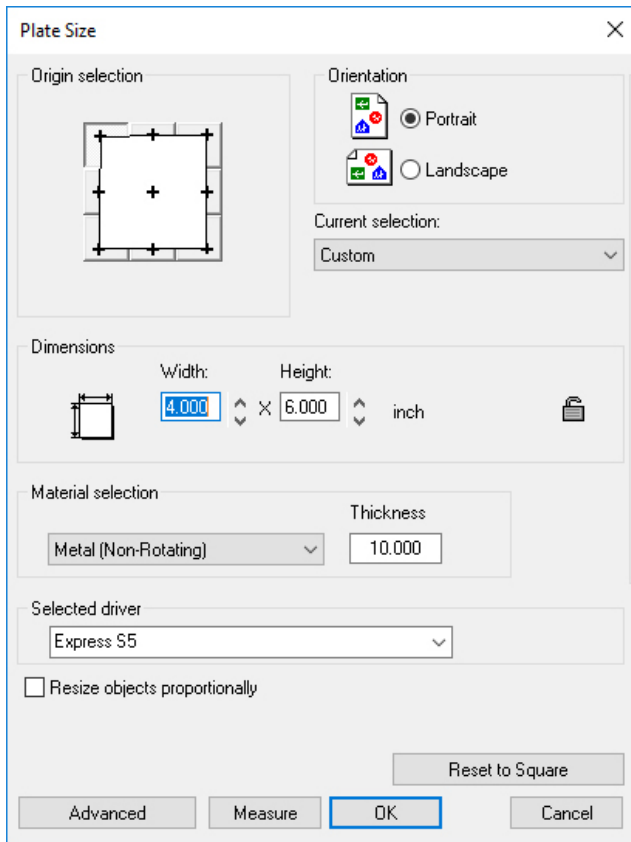

Then, we will enter the text using the Frame Text Compose tool as shown below.

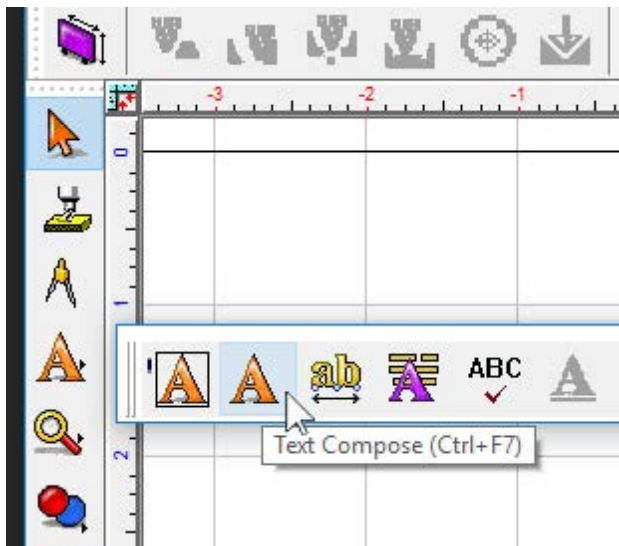

With this tool selected, text will automatically be centered and have automatic Kerning. In the below example, the font was changed to Casual1, with a height of 1.250 inches and a slant of 19 degrees. The

top and center lines are left justified and the bottom is center justified in order to produce a sloping look to the sign. All of these adjustments are available when entering text in the Frame Text Compose mode.

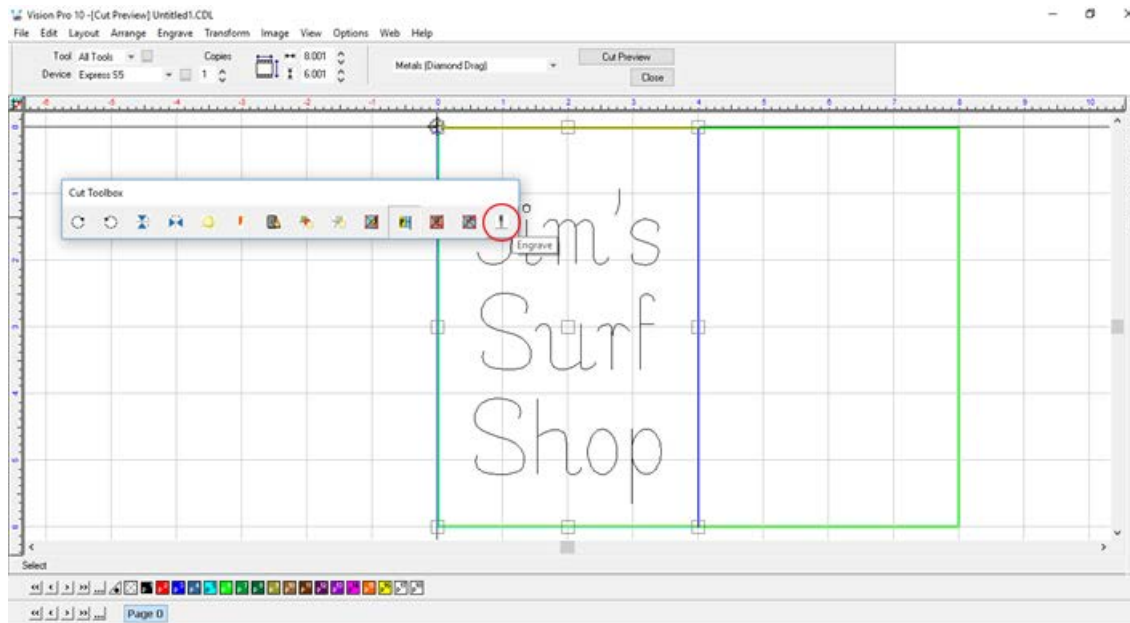

Once the file has been set up, select the Engrave Icon from the left toolbar, click on the Tool Setup icon and from the Materials selection drop down list, select Engravers Plastic(Engraving), then click on OK. In the picture below, the Cut Toolbox shows that the Vacuum, Prox, Dry Run, and Spindle are all enabled. Since this is the second example job, sending a Dry Run job to the engraver is suggested.

Select the Engrave Icon to send the file to the engraver.

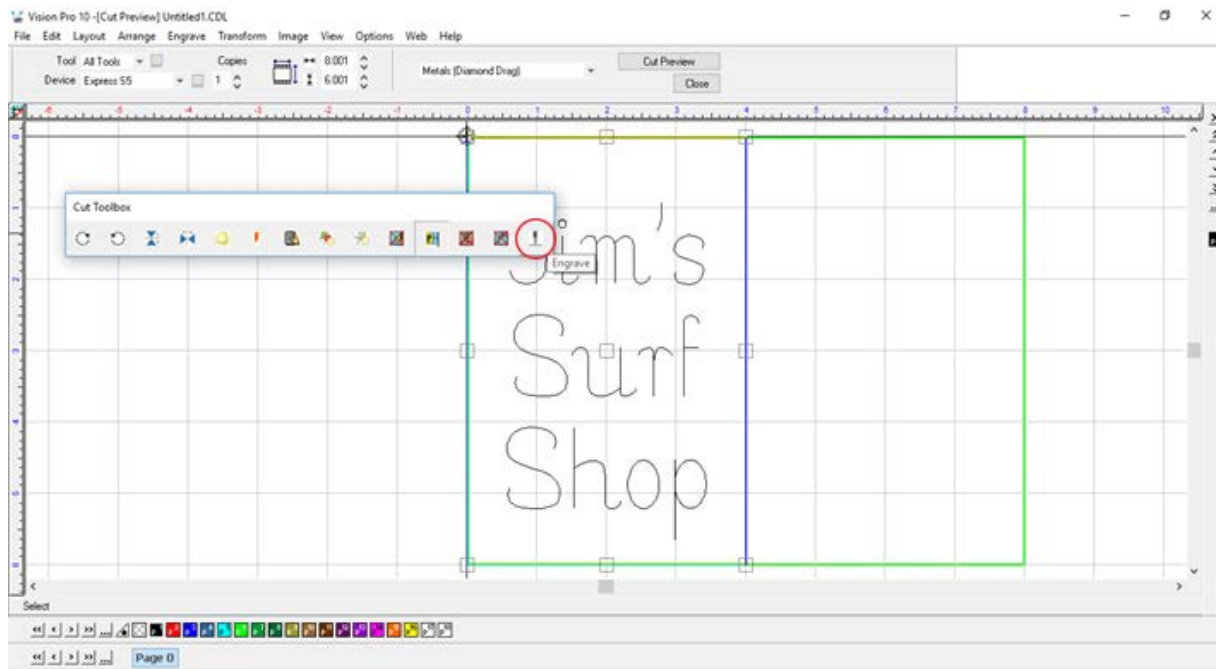

Place the material on the table (shown with Multi Mat on the t-slot table to hold the engraving material in place), and press the start button on the machine to begin engraving.

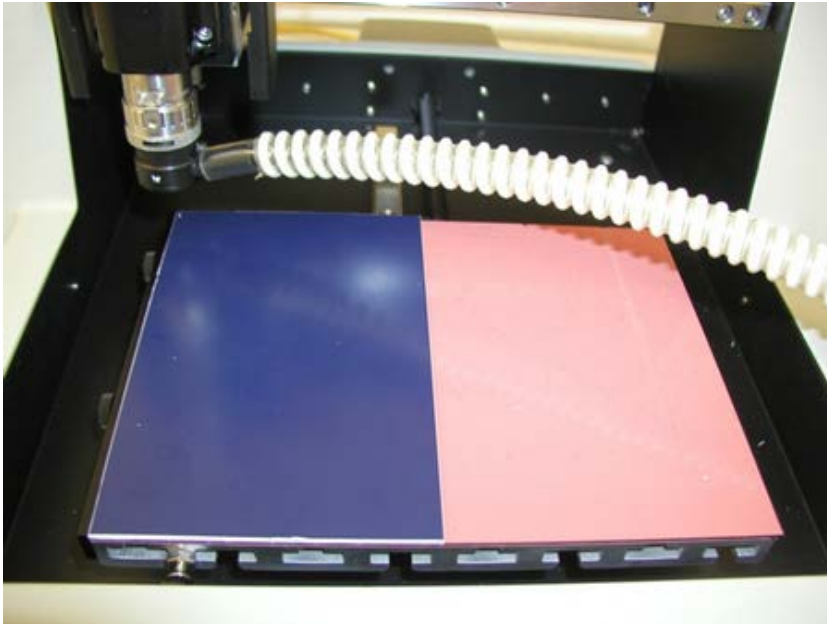

**NOTE:** The design of the Vacuum Chip Removal System is to clear the debris away from the engraved material and prevent the chips from scratching the surface of the material during operation, and/or getting trapped between the nose cone and the material (when using the proximity sensor function) and causing the engraver to not engrave to the proper depth.

When the file is complete, remove the material from the table. HINT - Use a light bristle brush to clean out any debris that may remain in the engraved characters.

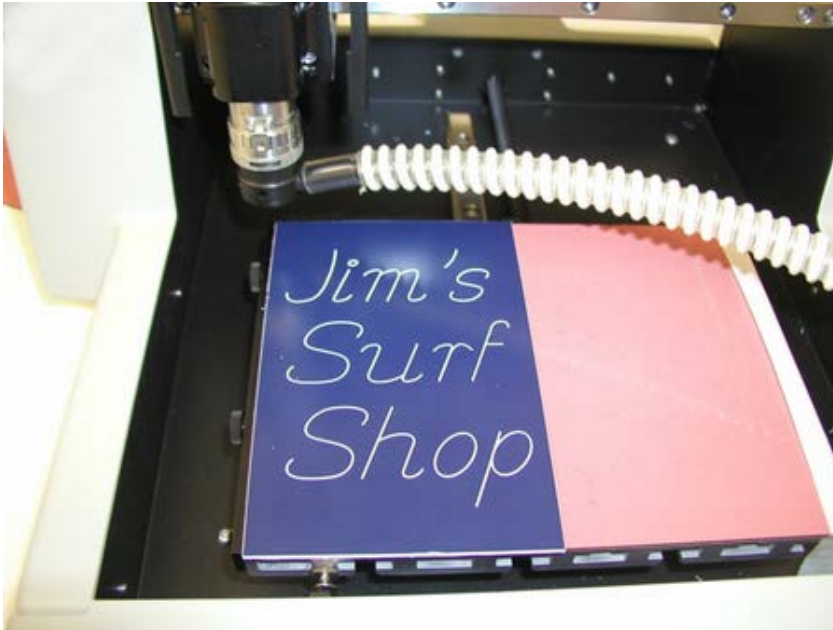

### 5.4.3 Burnishing

In this section, we will set up to engrave with a burnishing cutter. The figure below shows the Vision Express spindle with a burnishing cutter and an optional EZ Rider burnishing adapter.

**The Vision Express spindle with burnishing cutter**

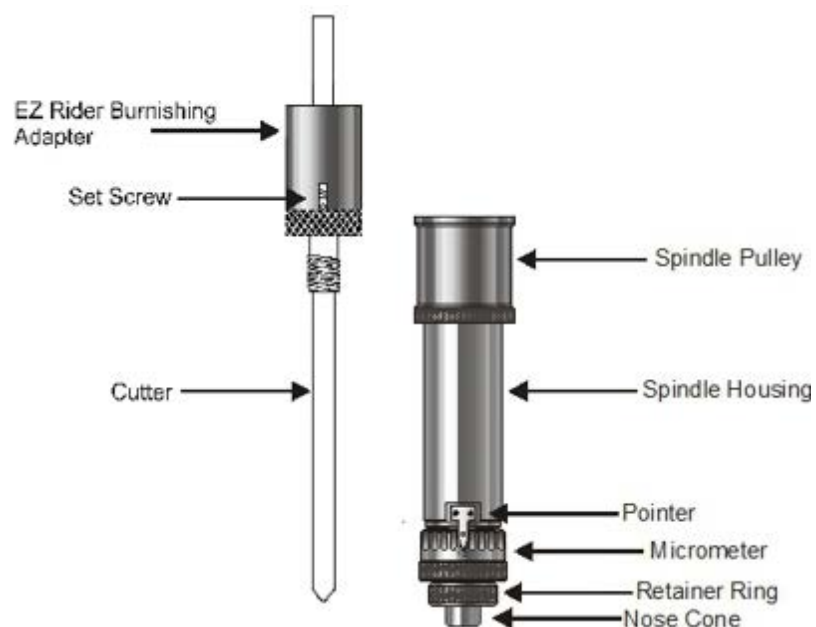

Burnishing is different than standard rotary engraving mainly because the nose cone is not used to set the depth of cut. Burnishing does not actually cut deep into metals, rather it cuts the painted surface off of metals. To effectively burnish, it is recommended to use an optional EZ Rider burnishing adapter. This helps to control the pressure of the cutter applied to the material. Burnishing requires less pressure than other types of engraving and the EZ Rider attachment applies the proper amount of pressure for burnishing.

Installing the EZ Rider is similar to using a cutter knob. First, screw the EZ Rider into the top of the spindle hand tight. Next, insert the cutter through the EZ Rider and spindle so that the cutter sticks out below the nose cone approximately 1/4 inch (6 mm). Tighten the set screw in the EZ Rider to hold the cutter in place.



In order to set the engraver up for burnishing, we will need to perform a “Set Surface” function. From the home screen on the LCD panel, press on the Jog Icon. Use the arrows to move the spindle over the material that was placed on the T-Slot table. Lower the burnishing tool with the Z down button until the tip of the burnishing tool touches the material. Move the Z down approximately 0.03 – 0.05 inches (0.5 – 1.0mm) to preload the EZ Rider spring. Select the set surface button. The Spindle will rise to confirm the surface has been set. Select the go to home button.

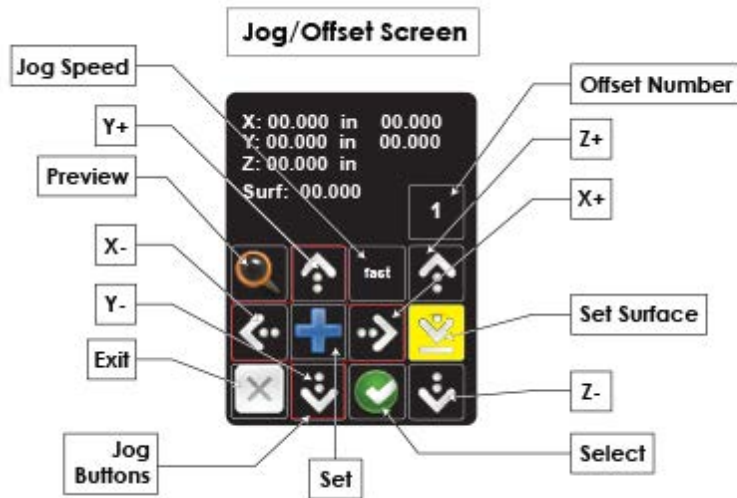

### 5.4.3.1 Example Job 3 - Burnishing

In this example, another feature in the Vision Software will be introduced. We will create a Plate Object in order to create multiple items with different text engraved on a single 8 x 6 inch (203 x 152 mm) piece of coated brass (also known as black brass or trophy brass). The plate will use a text import function from an external text file that will be copied into a plate template and the Vision software will automatically format the imported text.

Begin by selecting the Plate Size Icon and setting the engraving area to the standard Vision Express 8 x 6 inch area

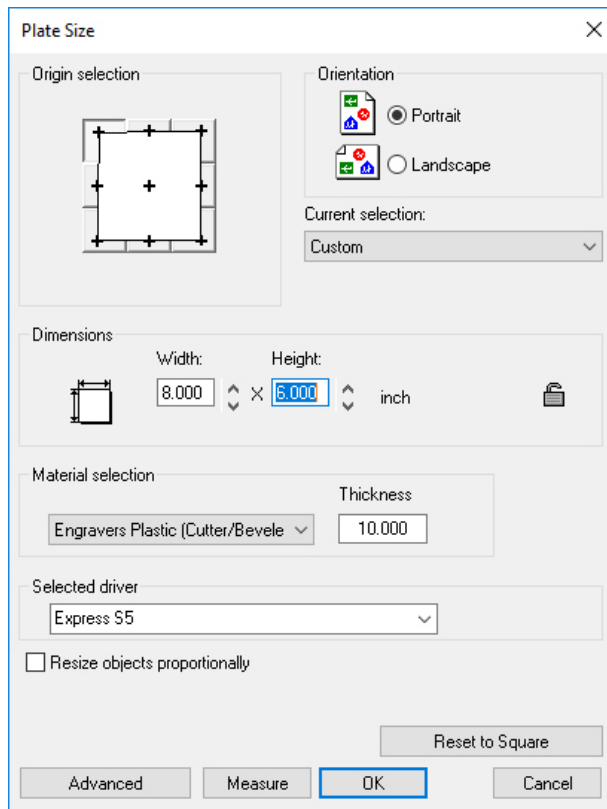

To create the Plate Object, select Layout → Plate Object → Create Plate from the top toolbar menu.

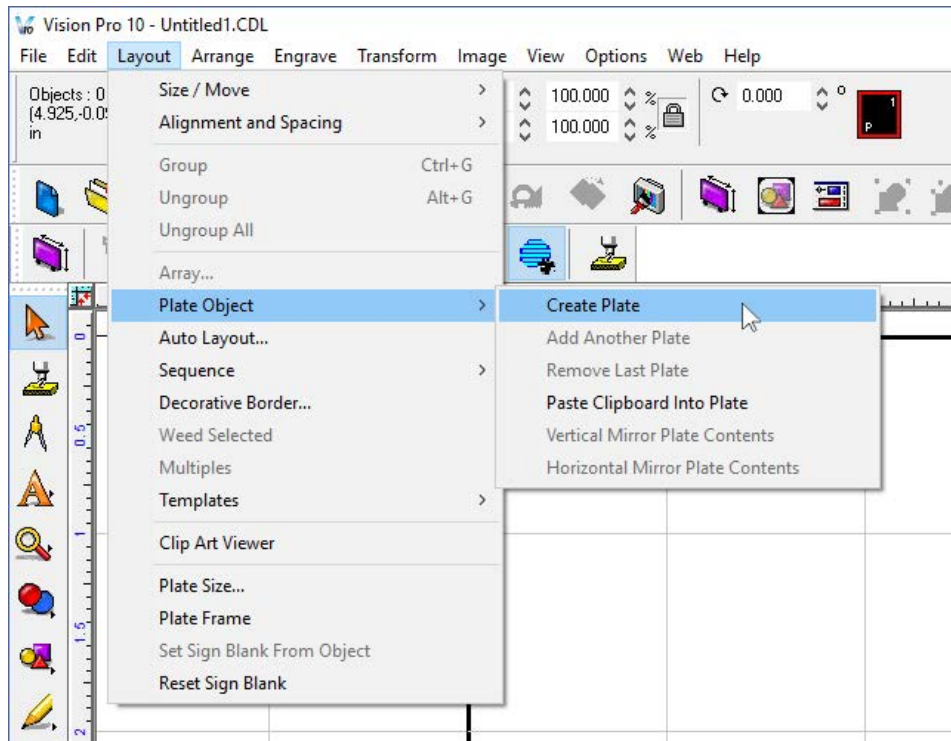

Adjust the number of plates to 1, leave spacing at 0.000 inches, width and height to 2.500 and 1.25 inches, set the page margins to 0.250 inches as shown, then click on Apply. Note that the page margins on the toolbar are located such that the top field is for the top margin, the left field is the left margin, etc.

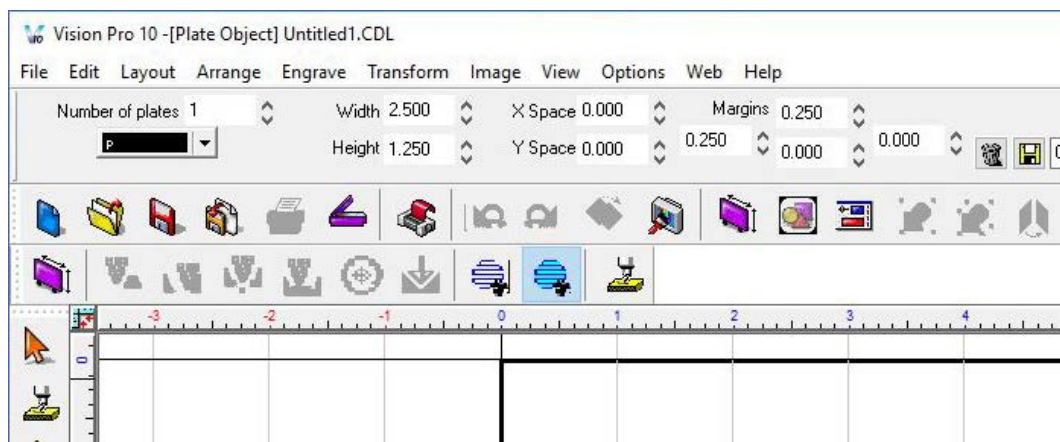

The screen should then appear as below.

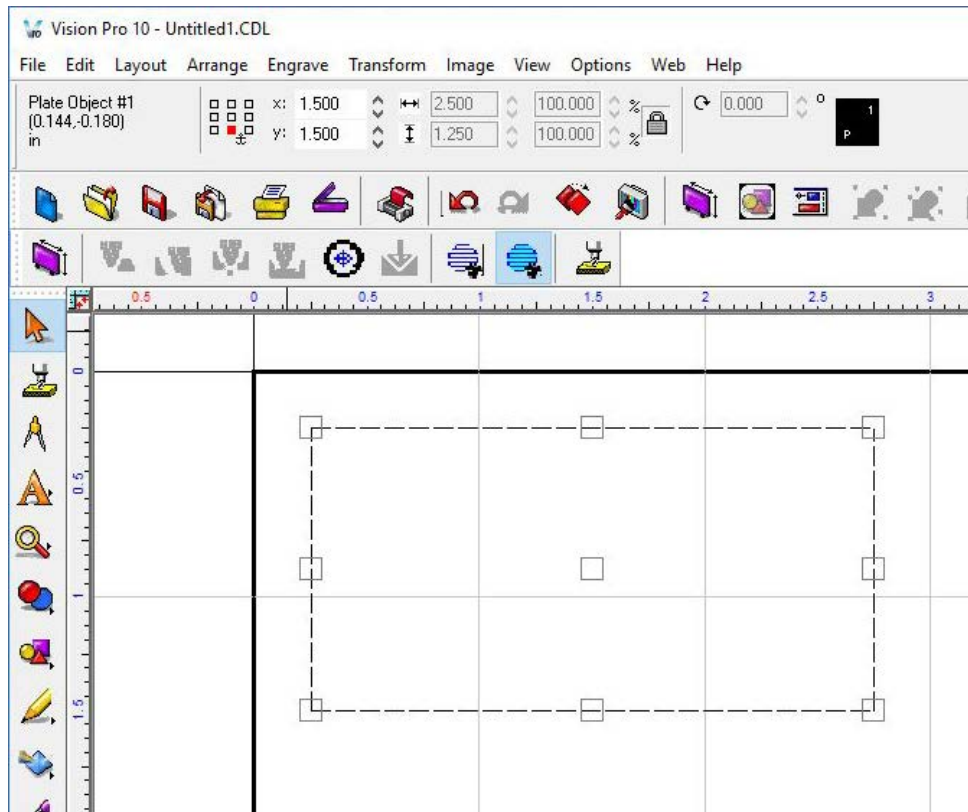

Select the Text Compose Icon.

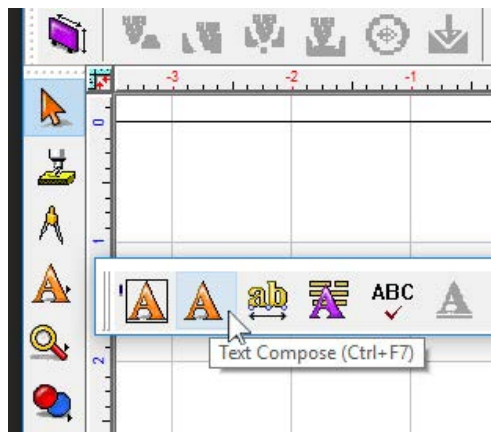

Click in the middle of the Plate Object.

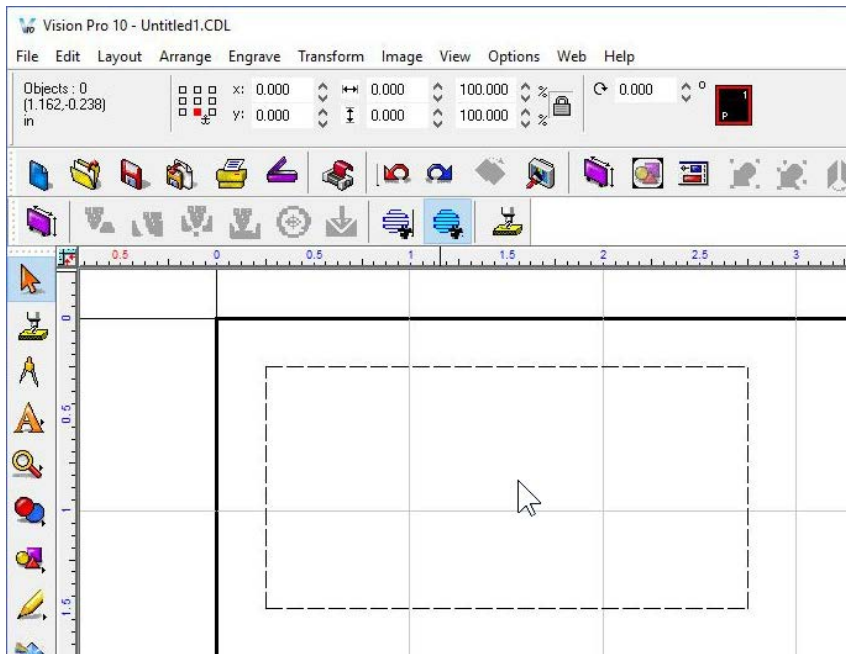

Enter any text in the format you wish to use. In this example, two lines of text are entered as variables (it does not matter what you type. The text entered is only for formatting and will be replaced with the text imported from the .txt file).

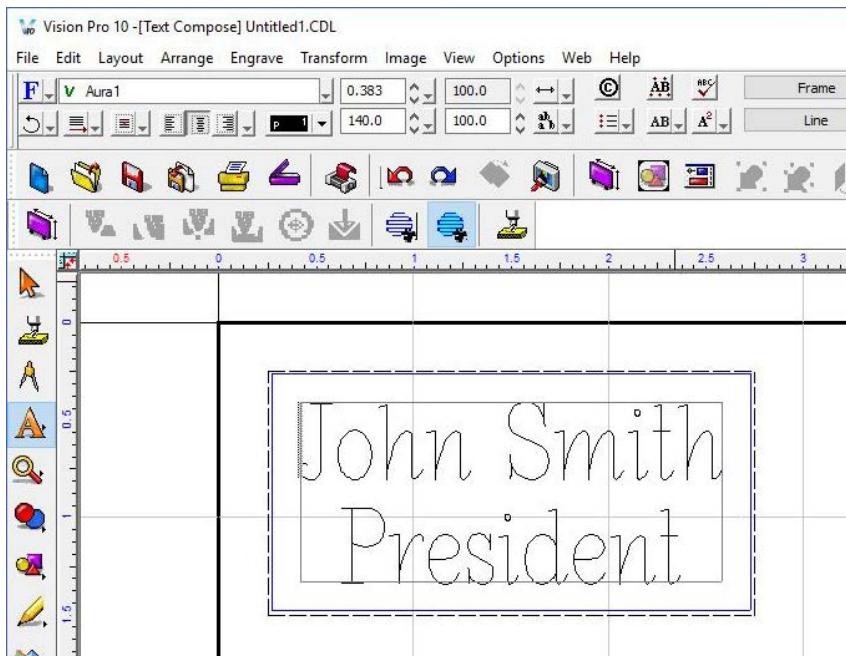

Each line of text can be independently set for font and size. Highlight the text to be changed, then from the font list on the top toolbar, choose the font to be used for the selected text and double click on the font name.

If the size or other parameters need to be revised, use the toolbar fields to modify the font style. Please note that in this example, the Width Compression for the text was adjusted. In order to adjust the Width Compression, select the Menu button, edit the Compression field (shown below).

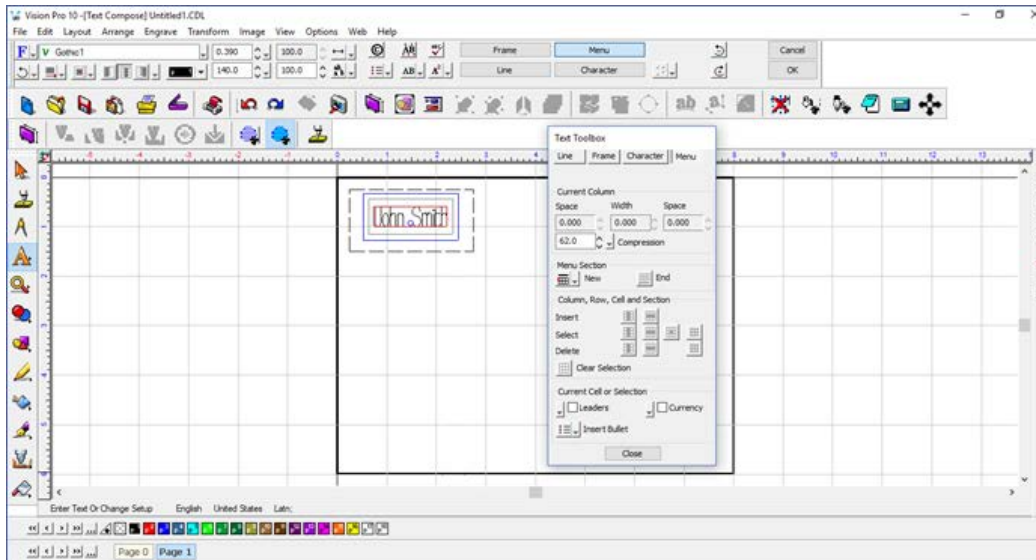

Select all text and select the Width Compression Mode by clicking on the drop down list (as shown). Change the settings to Always compress or expand text to fit width, Method: Width compress/expand, and Apply to: Each Line Individually. Deselect Word Wrap, then select OK.

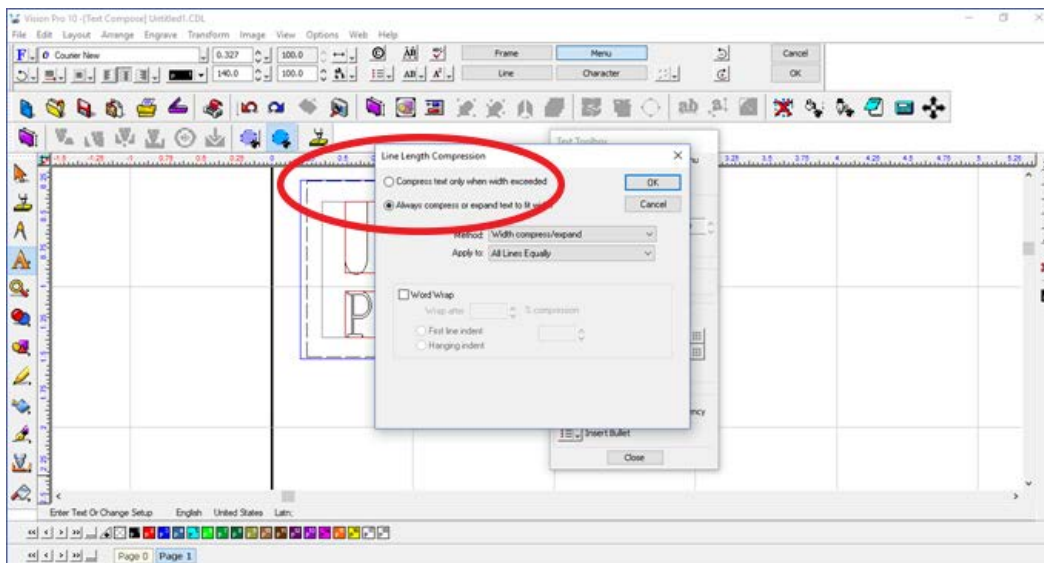

For a detailed description of all the font modifications possible, refer to the Vision software help or user manual.



Once changes have been made, deselect text mode by clicking in any open area of the screen, away from the plate object.

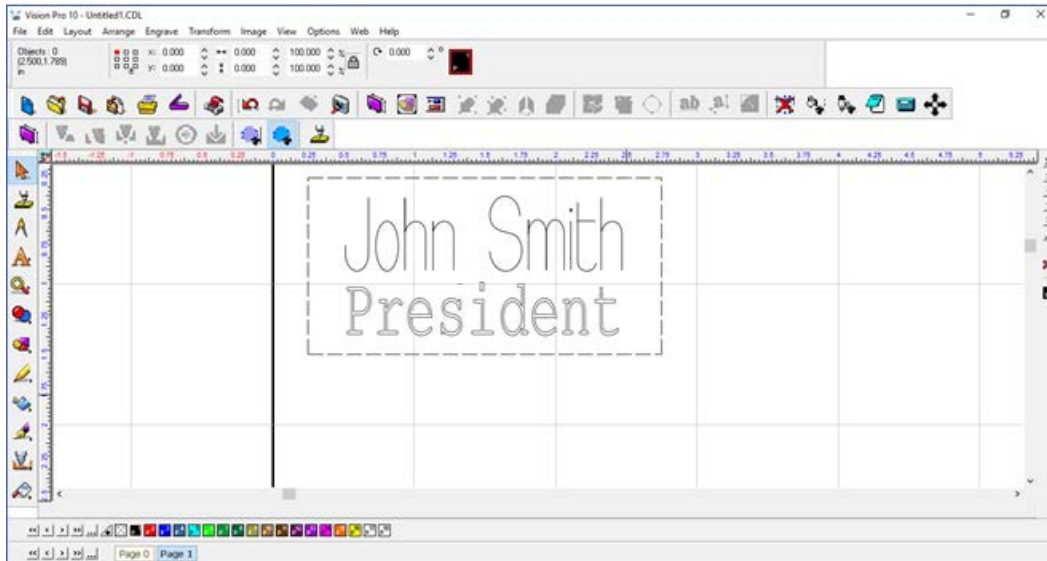

In this example, a text file was created in order to copy and paste the variables into the Vision software. Highlight the text and select copy from the edit menu (or right click and select copy). Note that in this example, the two variables are entered as subsequent lines in the text file and that there may be difficulties when importing from other file formats. A simple text file created in Windows Notepad is suggested.

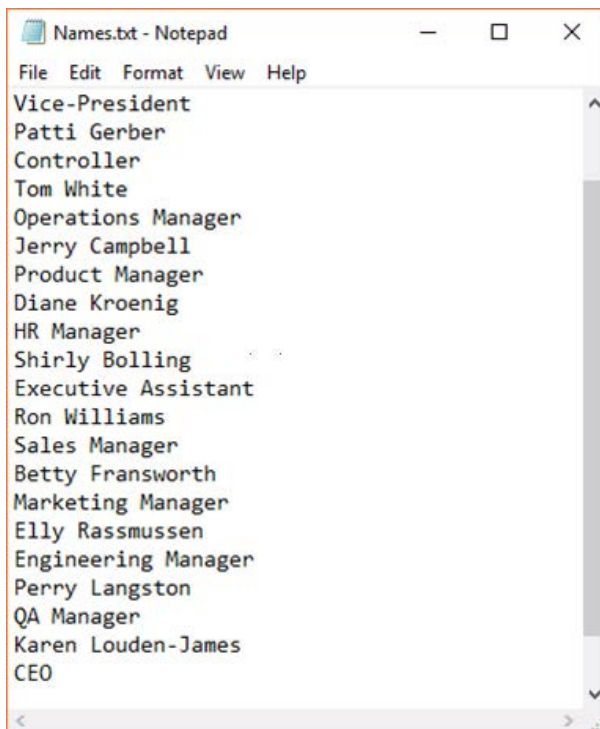

To insert the copied text, select **Layout** → **Plate Object** → **Paste Clipboard Into Plate**.

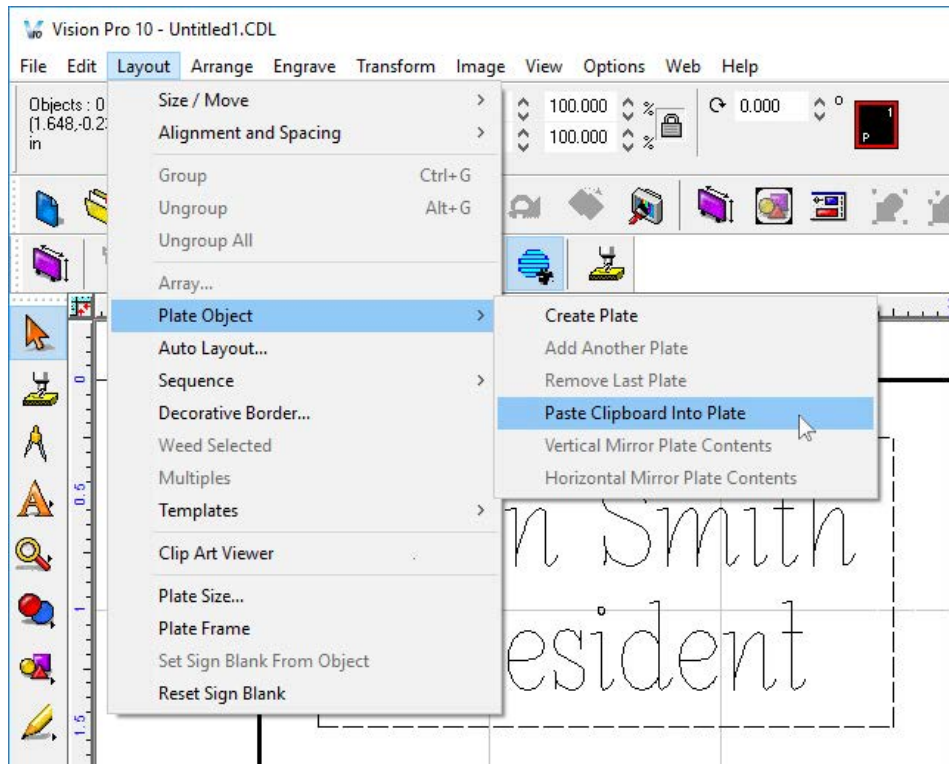

Click in the center of the plate.

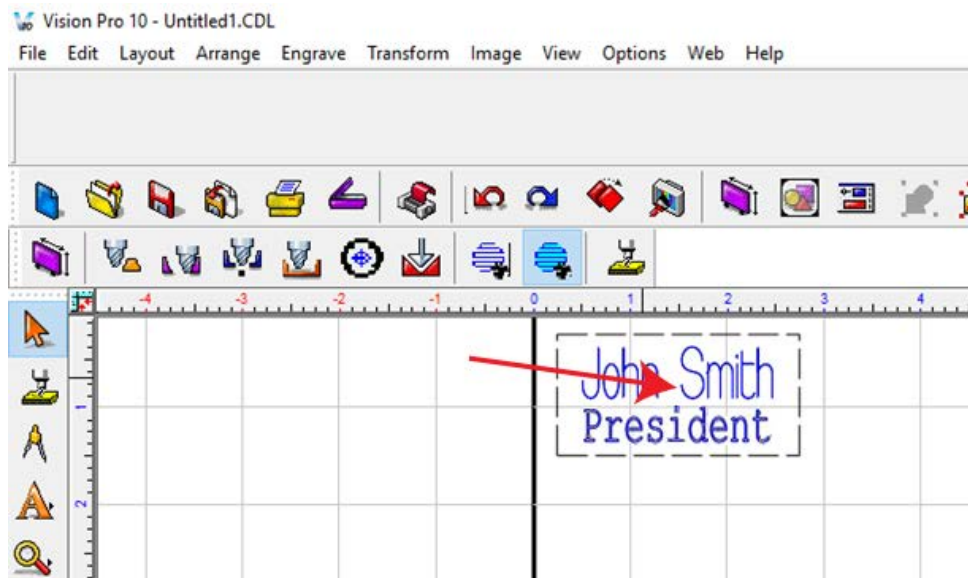



After clicking in the center of the plate, all fields are merged and multiple plate objects will be created based on the number of text variables selected.

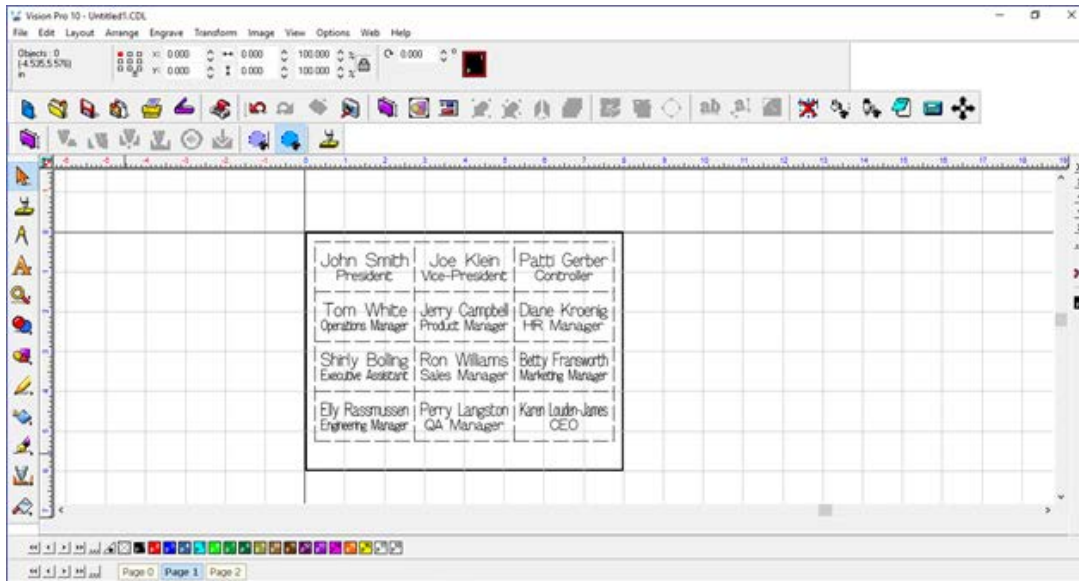

Also, if there are more variables than can be fit into one plate in the Vision software, multiple plates (or pages) are automatically generated for individual output to the engraver. The lower right corner of the Vision software screen allows the user to view the individual pages. During the Engrave operation, the user will select the page to be sent to the engraver.

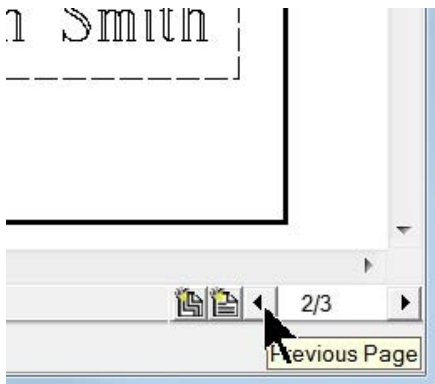

To finish this example job, set up the engraver for a metal burnishing application as described in the previous section and select the Engrave icon from the left toolbar, then click on the Tool Setup icon, chose Metals(Burnishing) as the material and click on OK. If you choose to run a Dry Run (as shown) to make sure the setup is correct, proceed as in prior sections to send the file to the engraver.

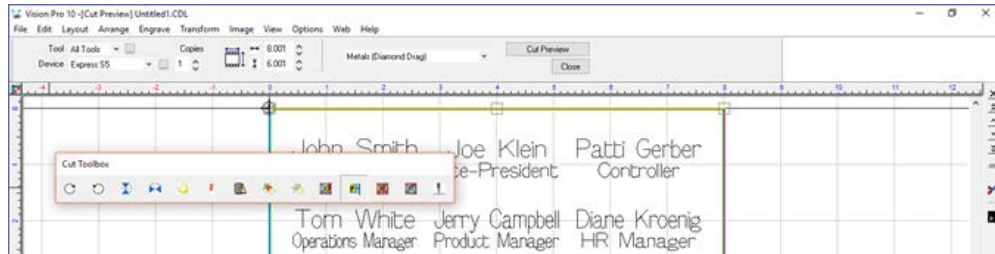

Note – In this example a toolpath was added to the plate objects to show where the name badges will be cut. (plate objects are shown in image below)



### 5.4.4 Profile Cutting

In this section, we will set up to engrave with a standard engraving cutter and cut completely through engraver's plastic with a cutter/beveler. The cutter/beveler is used to create a contrast on the edge of the cut material. The figure below shows the Vision Express spindle with a rotary cutter/beveler.

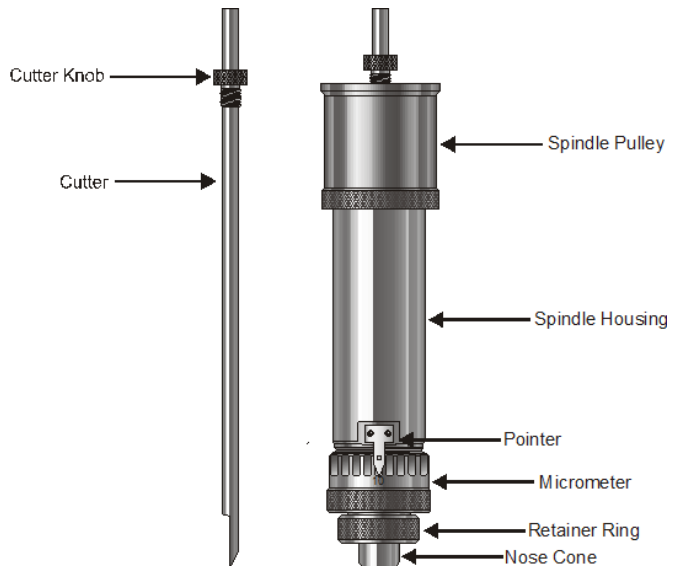

5.4.4.1 Example Job 4 - Profile Cutting

In this example job, engravers plastic will be set up to engrave a name badge and then the badge will be cut out. 1/16th inch standard engravers plastic is used. Two different tools will be used - one to engrave, and one to profile cut the edges.

As with Example Job 2, the Vacuum Chip Removal System is highly recommended for this application and is shown in this example.

Prepare Artwork in Vision Software

First, we draw a rectangle using the shape tools

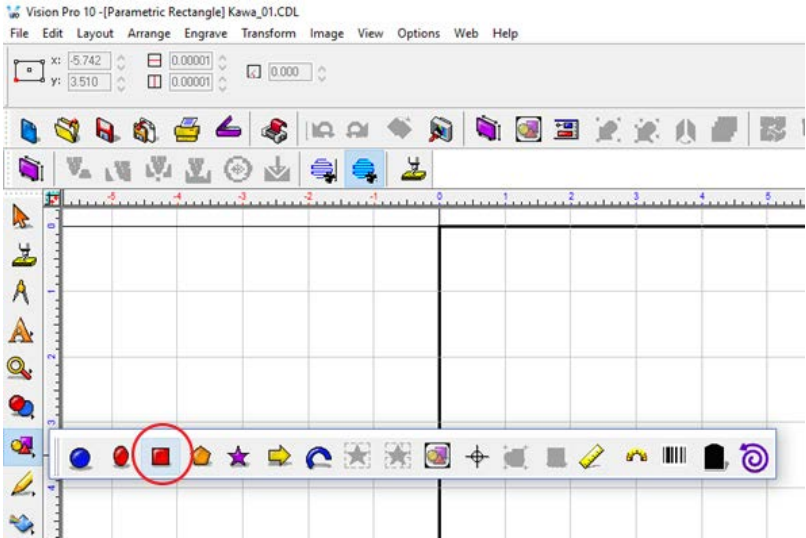

Size the rectangle to be 3" X 1". Set the X bounds to .25 and the Y to .25 to position the badge .25 inches away from the edge guides.

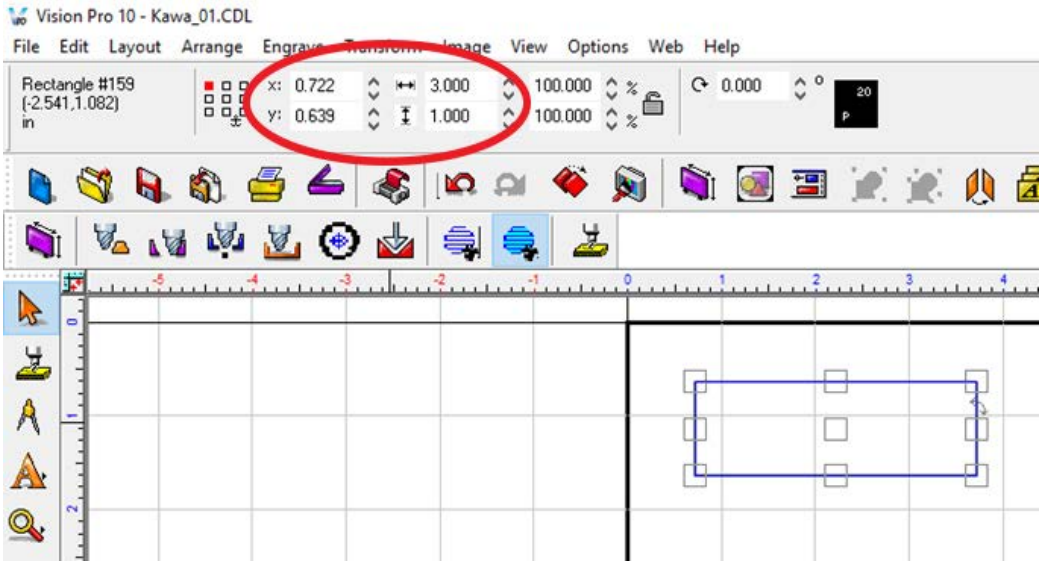

Now we round the corners by selecting the rectangle and pressing the round corners icon. In the text box put in .100 and click apply.

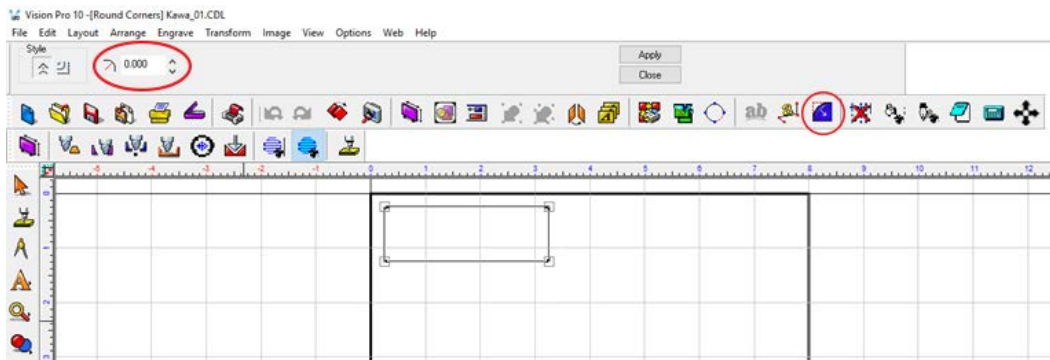

Use the Frame Text Compose Tool to add text to the badge.

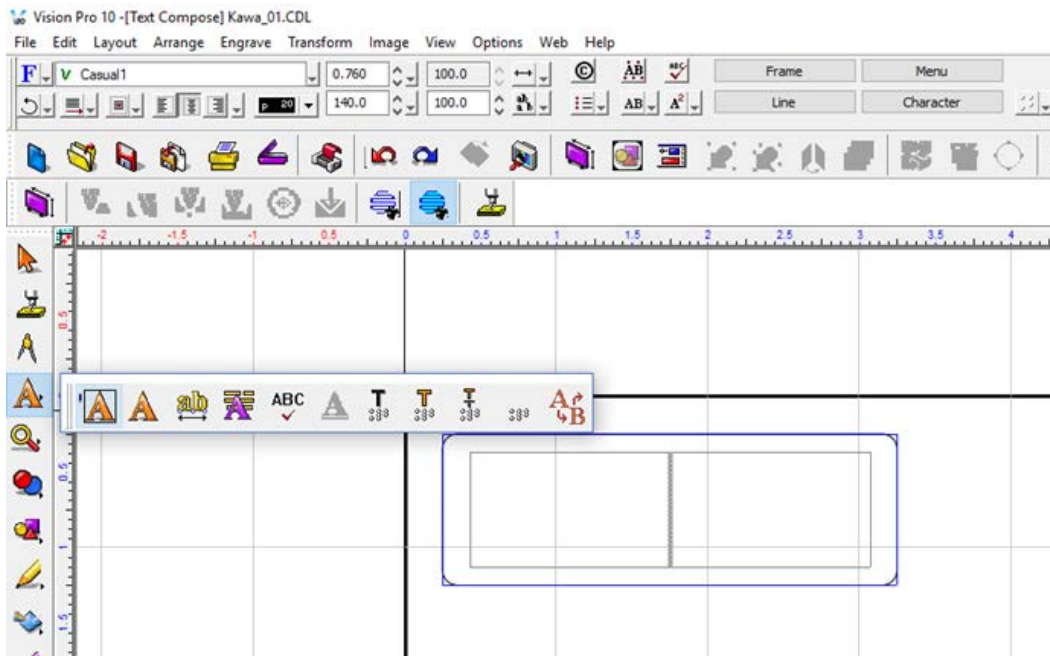

Now make a male tool path by clicking on name badge and then pressing on the male toolpath icon.

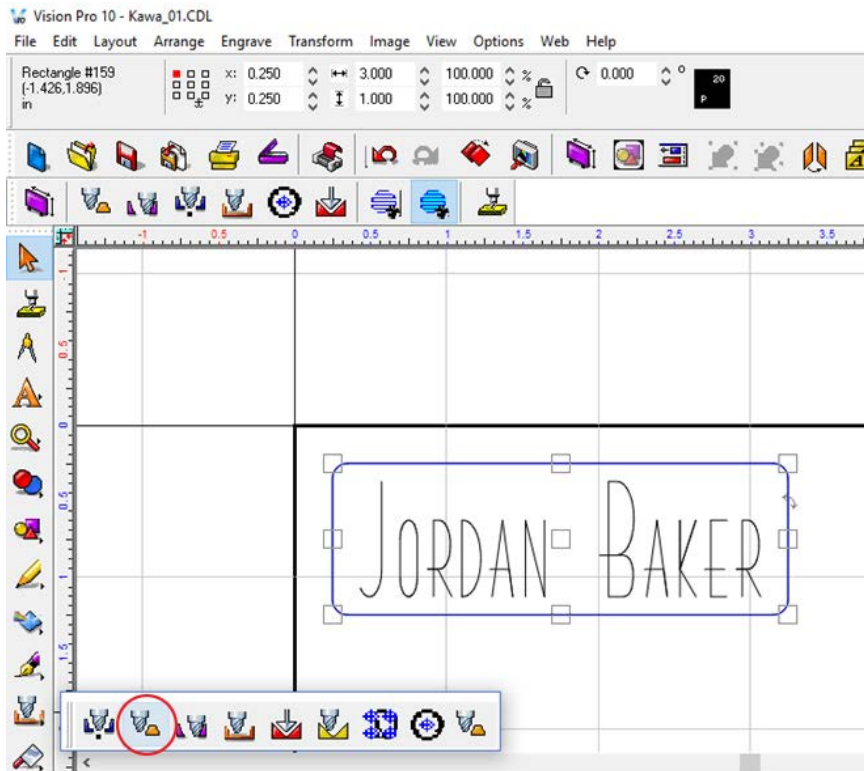

In the Tool Path screen select the profile cutter you are using the depth, and the color you would like to use for your cut path. (Here we use Red) Press Ok.

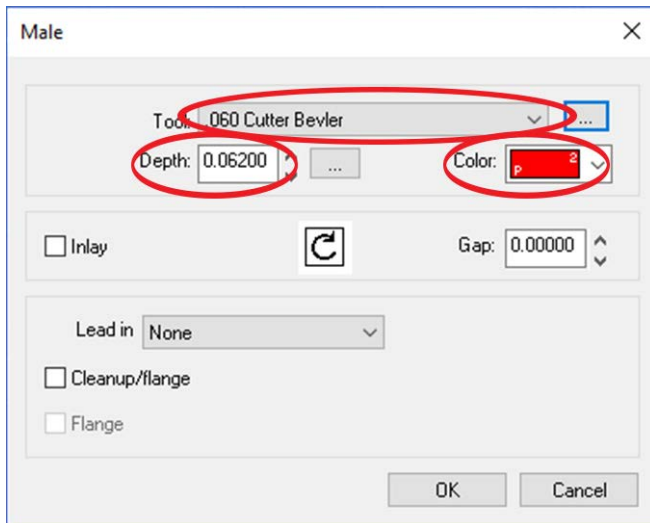



### Holding Down Material

Secure the material on the t-slot table. It is best to use Multi Mat to hold the material in place. The multi mat is great for holding the material when engraving and can also be used when profile cutting all the way through thinner materials. Another procedure is to use a piece of sacrificial material on top of the Multi

Mat. DO NOT place the material to be cut directly on the t-slot table. If you do, then the cutter will cut into the t-slot table and permanently damage the surface. Other methods for holding material down are in the section Holding Down Material.

### Setting Cut Depth for Engraver

To install the rotating cutter for engraving, loosen the set screw on the cutter knob with the supplied cutter wrench and move the cutter knob to about the mid-point of the cutter tool, then lightly tighten the set screw. Insert the cutter into the top of spindle and lower it until the cutter knob can be screwed into the spindle. Tighten the knob COUNTER-CLOCKWISE (when viewed from the top of the spindle) until it is hand tight.

Then, you must zero the cutter. To do this, you must first turn the micrometer so that the pointer points to 0. Note - it is helpful to first turn the micrometer to the left (clockwise) until threads just start to appear on the spindle. This allows for sufficient depth adjustment when turning the micrometer to the right). Zero the cutter, then set the engraving depth as described in the Rotary Engraving section.

Select the text to be engraved and then click on the engrave icon. Press the magnifying glass on the machines touchscreen to preview the engraving area. When ready, press the play button to engrave the material.



### Setting Cut Depth for Cutter/Beveler Tool - Standard Method

If you have measured the thickness of the material to be cut, you can adjust the micrometer in two ways

1. Adjust the cutter to cut through the material PLUS 0.001 - 0.003 inches (0.0250 - 0.075 mm). This method will produce a clean cut of the parts and lightly cut into the sacrificial material underneath, or



- Adjust the cutter depth to cut through the material MINUS 0.001 - 0.003 inches (0.0250 - 0.075 mm). This will create a "kiss cut" that will leave a very thin amount of material which holds all of the parts together, and then the parts can be snapped apart after removal from the engraver. This second method is ideal in production environments where part handling is an issue.

### Alternate Method for Setting Cut Depth for Cutter/Beveler Tool - "Stacked Material Method"

As an alternate to dialing the micrometer 50 or 60 clicks to set the cut depth on 1/16th inch plastics (or up to 130 clicks for 1/8th inch material), this second method utilizes a second piece of the same kind and thickness of material to be cut to set the cut depth. Refer to the below diagram - the material to be cut is placed on top of the sacrificial material/Multi Mat materials.

The material to be cut is held in place either with double sided tape or by the spray adhesive/transfer tape method detailed in the Holding Down Materials section. Then a second piece of material is placed on top of the material to be cut.

The nose cone is lowered on top of the second piece of material (near its edge) and the cutter is adjusted downward until it touches the top of the material to be cut. This, in effect, sets the cut depth to match the material thickness. The cutter knob set screw is tightened, then the micrometer is adjusted, either for a through cut (turning clockwise) or a kiss cut (turning counter-clockwise), 1 - 3 clicks.



Go to the software and click on the red toolpath. Press the engrave icon and change the material settings to Engravers plastic (Cutter/Bevler). Now press the engrave icon to send the job to the machine.

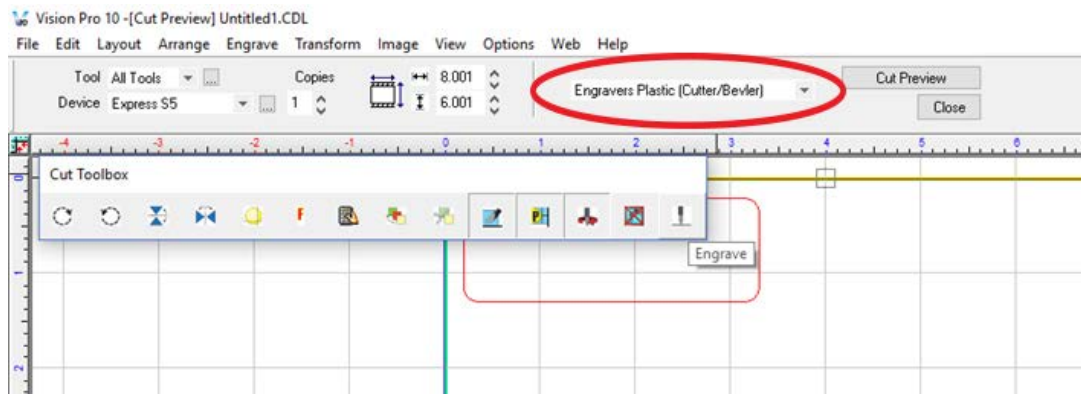

Press the magnifying glass on the touchscreen to preview the engraving area. When ready press the play button to start the profile cut.



## 5.4.5 Vectorizing Bitmaps and Creating Vector Fills

In this brief section, the commonly used techniques of importing a bitmap and vectorizing it for engraving/cutting, and the process of adding a vector fill to an outline will be demonstrated.

It is often required that a scanned image or a bitmap file is requested to be engraved. Since the Vision engraver is vector based and requires vector lines in order to follow a path for engraving, these bitmaps will need to be converted to vector images before being sent to the engraver. In many cases, the outline itself does not represent the graphic properly. The middle of the image will need to be engraved as well, and this requires a vector fill to be added to the vector image, so that the engraver can create larger/wider engraved areas.

### 5.4.5.1 Vectorizing a Bitmap in Vision Express 9 Software

The Vision 10 software has a new and vastly simplified method of creating a vector outline from a bitmap image. Vector outlines are automatically created when the bitmap is imported in the drawing. The following procedure can be used to import custom logos or images into the Vision 10 software for engraving purposes.

Compatible file types - Whether the user wishes to scan an image and import it, or will be using a file already created in another program, the image **MUST** be in a black and white .bmp format in order for the software to quickly create a vector outline. It is critical that the image be created at a high enough quality before creating the vector outline.

If the image has been printed and the user needs to scan it before importing it into the Vision 10 software, the image must be scanned at a recommended 300 dpi, then saved as a .bmp file format. Lower resolution images may not allow the software to create a good quality outline.

Open the Vision 10 software and create a new file in the desired plate size. Then simply select File Import from the top toolbar menu.

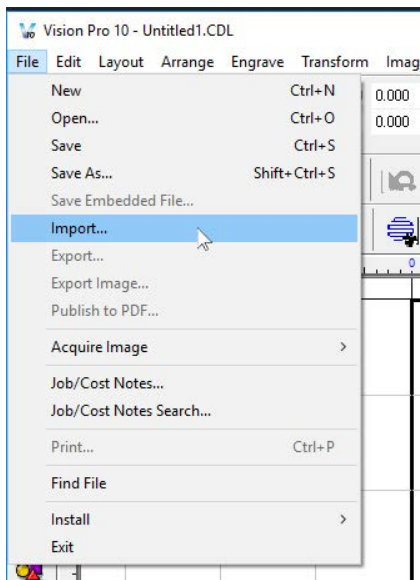

Using the drop down menu for Files of type, select Vectorize bmp (\*.bmp), then choose the file and select Import.

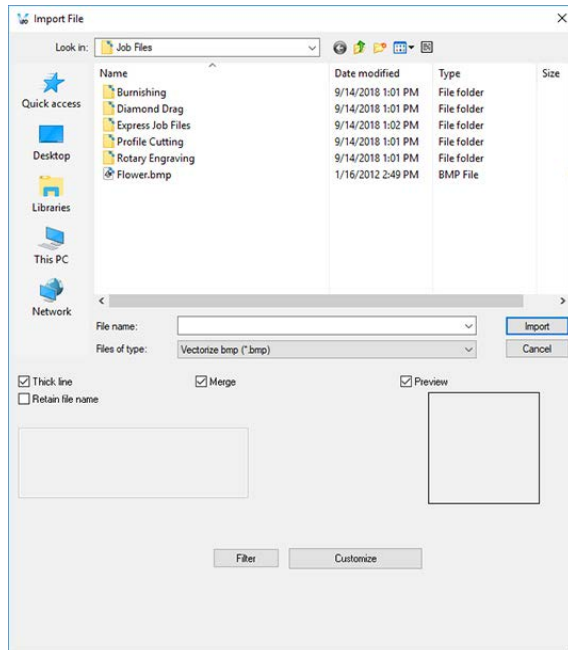

The next screen has only one adjustment - Alignment Bitmap Density. There is a slider bar for darkening or lightening the image to show more or less detail. The default slider position is recommended. Select OK and the bitmap will be automatically converted to a vector outline for engraving.

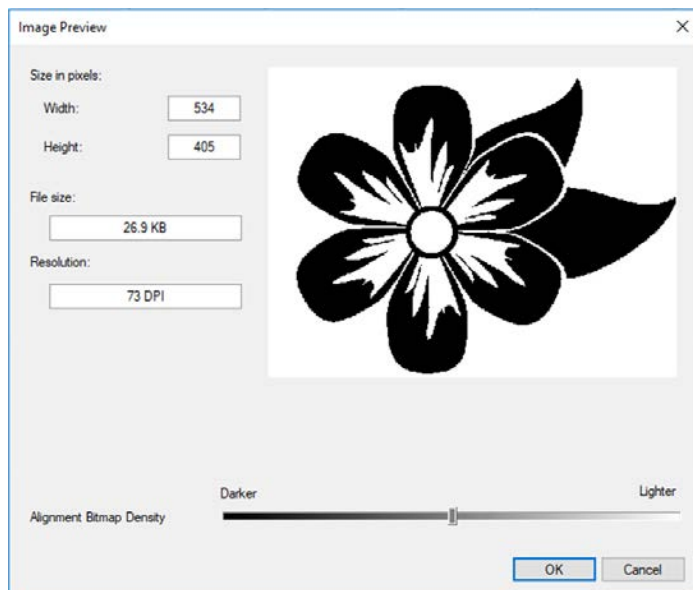

The final image is shown below after it was imported and converted to a vector outline. It is ready to cut or engrave.

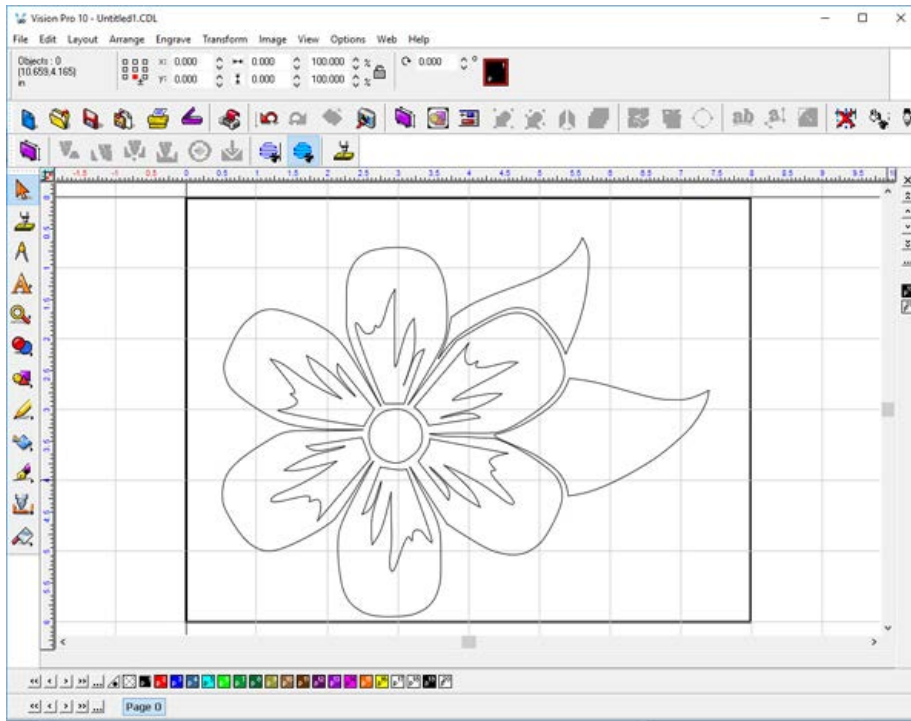

#### 5.4.5.2 Vector Hatch Fills

When an outline of an object needs to have the interior, or sections of the interior engraved, the Hatch Fill tool is used. As an example, if a simple circle is drawn in the Vision software, but the user wants to engrave the entire circle, not just the outline, a hatch fill is used to create the vector fill path for the engraver to follow. In this section, three applications of a hatch fill will be shown.

### Filling a simple object

After creating a new file in the Vision software, draw a circle using the Circle icon from the Shape Tools flyout menu,

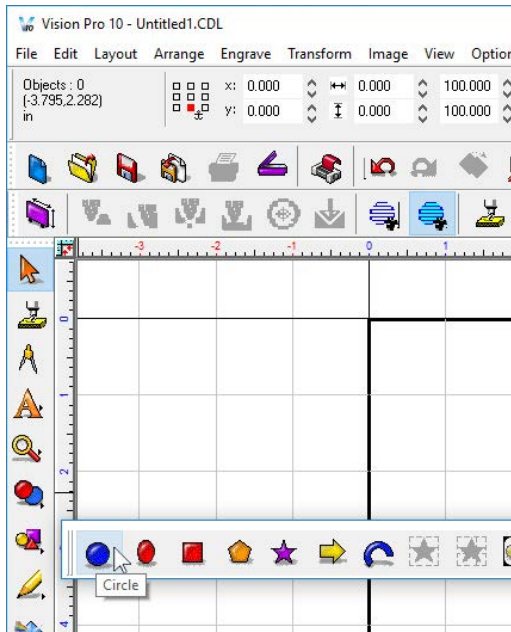

Click, hold and drag a circle, then select the Hatch Fill icon from the Stroke and Fill Tools flyout menu.

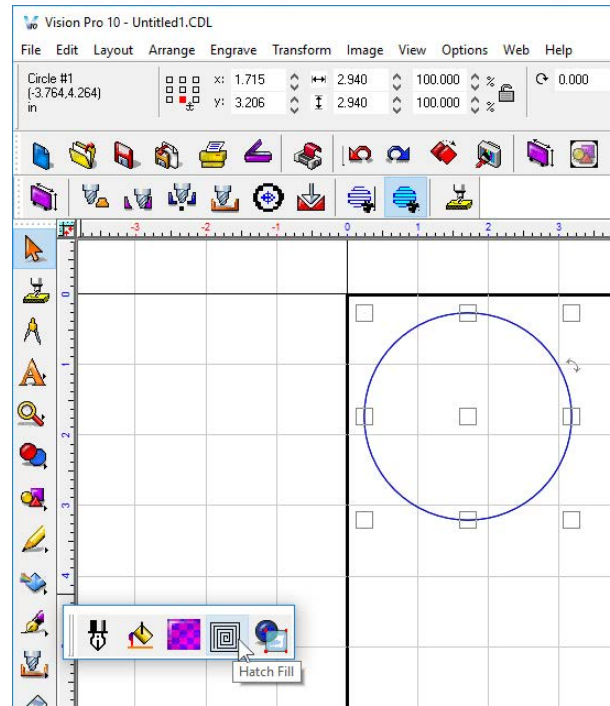

After selecting the Hatch Fill icon, the selected circle will be vector filled with the default settings. Note that on the top toolbar menu, tool options are now shown and the Tool width is set to 0.015 inches, Fill angle is at 0.000 degrees, the Fill style is S sweep and the color is Red.

When selecting the Tool width, it is recommended to have a 20 - 25% overlap on each stroke. To determine Tool width, the cutter tip width will determine the Tool width. If a cutter with a cutter tip width of 0.020 is being used, then the recommended overlap for the Hatch Fill would be  $0.020 \times 25\% = 0.005$  inches.

To produce an overlap of 0.005 inches, subtract 0.005 from the cutter tip width ( $0.020 - 0.005 = 0.015$  Tool width). If a cutter tip of 0.050 is used, then the overlap would be  $0.050 \times 25\% = 0.0125$  inches, so the Tool width for the Hatch Fill would be  $0.050 - 0.0125 = 0.038$  inches.

The user can experiment with different Fill angles and Fill styles to determine what looks best. Tool widths can be changed as well. More overlap creates a smoother background engraving, but requires more time. Less overlap will be faster, but the background can become rough. If the Tool width is greater than the cutter tip width, portions of the background will not be engraved. Doing so creates a visible hatch fill, which may be desirable for some applications.

Once the Hatch Fill has been adjusted, select Close from the toolbar menu. The image is ready to be sent to the engraver. You may want to change the hatch fill color to match the color of the outline, although it is not necessary.

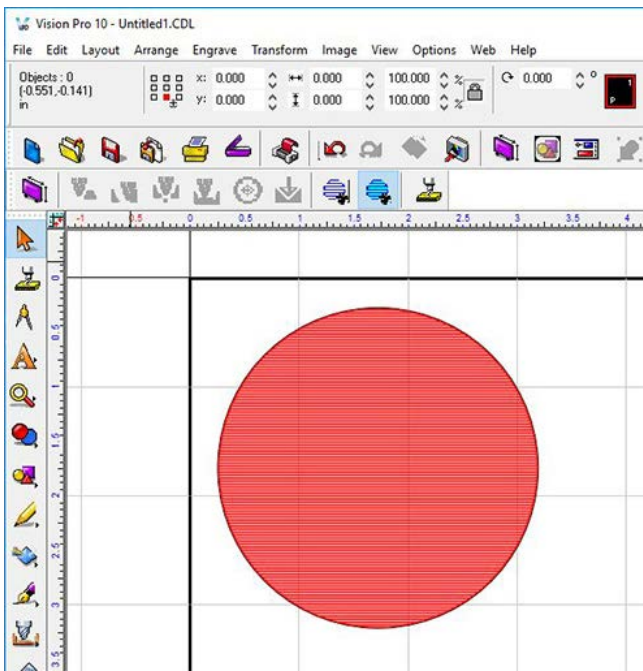

**Filling Outline Text**

Hatch fills can be applied to outline text, but not single line text. In the below example, Arial text was used by selecting the Frame Text Compose icon and clicking in the middle of the plate to create the text as shown.

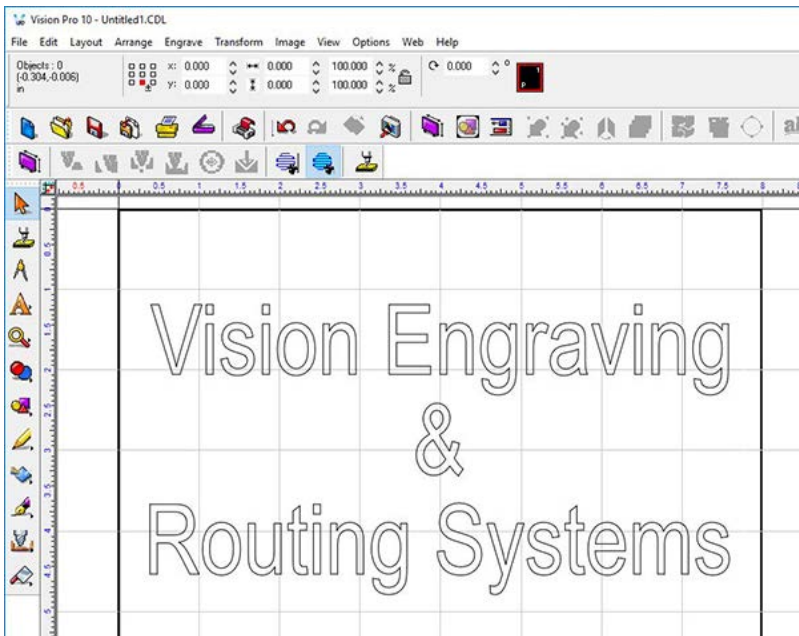



Before filling text, the user must first select the text with the Select Tools icon. Click on the Select Tools icon and select the text to apply the hatch fill to.

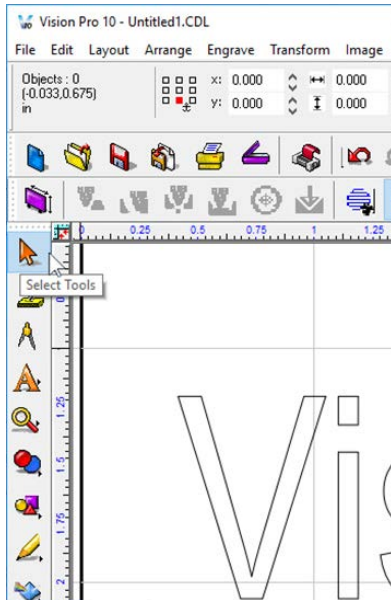

Select the Hatch Fill icon.

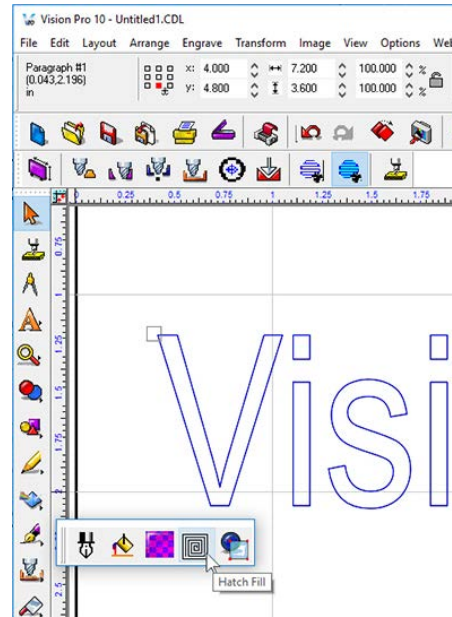

As with the previous example, the hatch fill is applied. Adjust the Tool width, Tool angle, Tool style and color as desired, then select Close. The file is ready to be sent to the engraver.

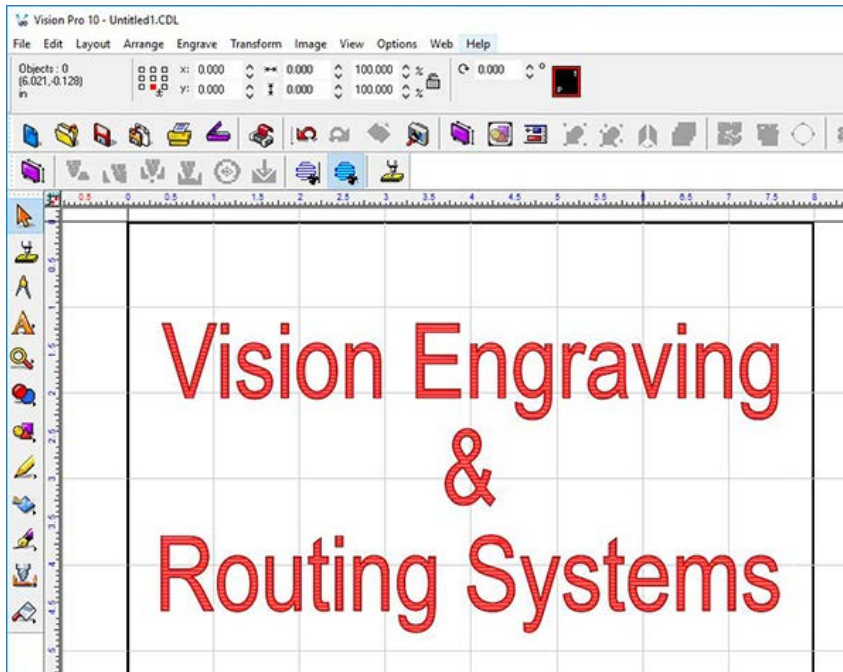



## Complex Hatch Fills

Some graphics have portions that do not need to be engraved and are within the boundaries of outside vector outlines. Using the Flower example file, import the file to vectorize the bitmap, then select the Break Path icon to separate the individual outlines.

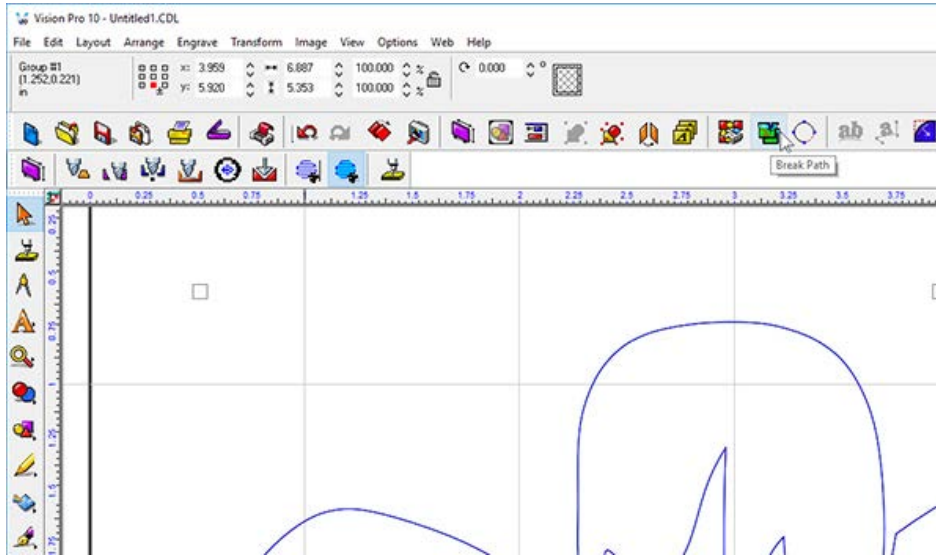

Next, we will need to create a path. The Vision Express software has an intelligent path tool that will automatically detect portions of the graphic that are within outside vector lines and will create a hatch fill with the center portions left as unfilled. Press the F3 button on the computer keyboard to select all items, then select the Make Path icon.

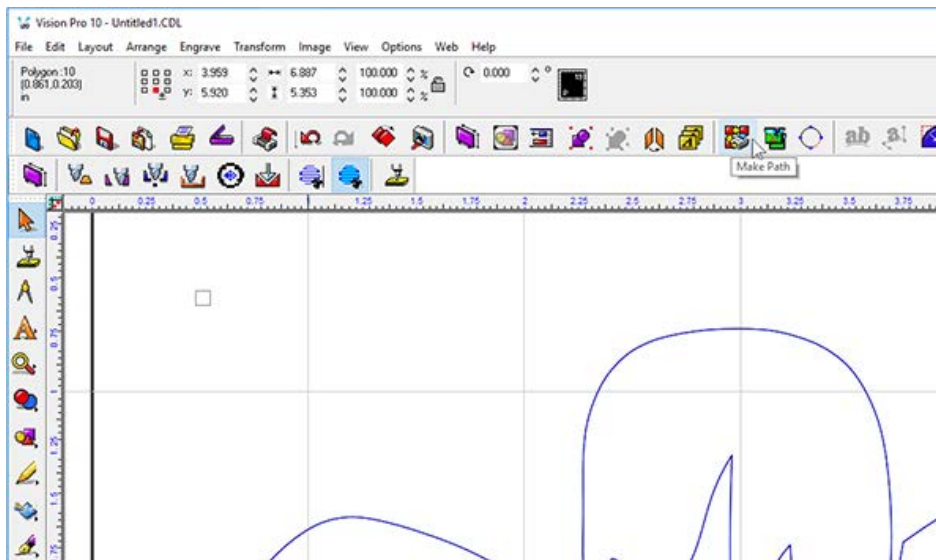

Then click and hold on the node in the center of the graphic. The automatic detection will display the areas that can be hatch filled.

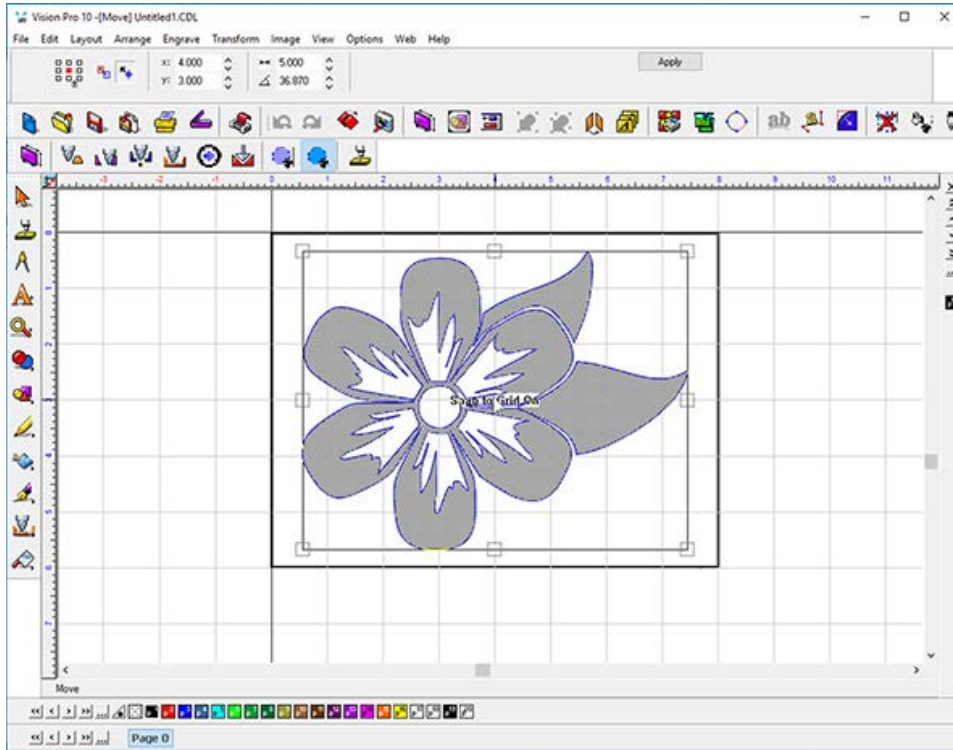

If this looks correct, select the Hatch Fill icon.

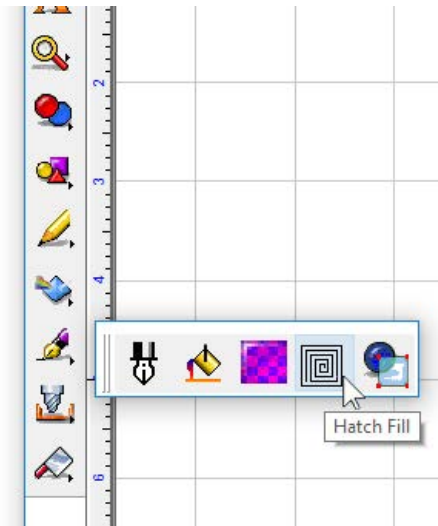

The hatch fill will be applied. Adjust the tool options as desired and select Close from the toolbar menu. The file is ready to be sent to the engraver.

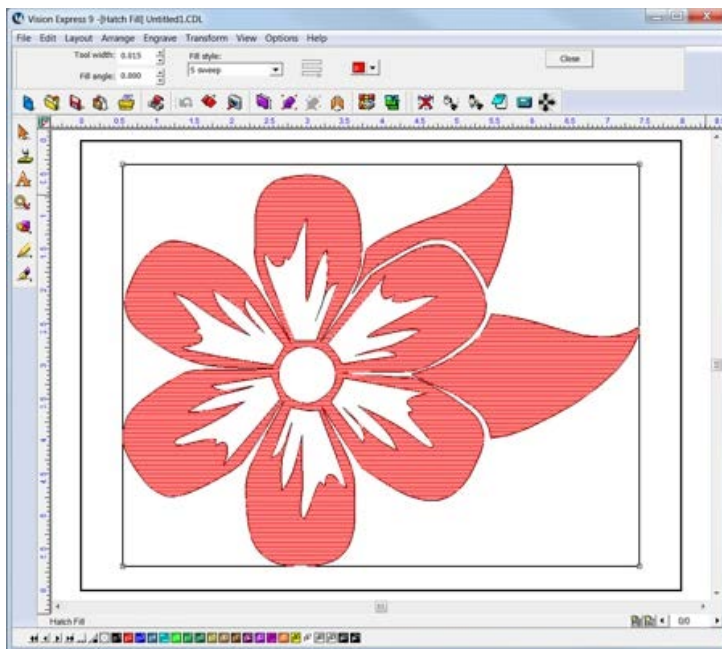

## 5.5 Advanced Operation

The following sections are for users that have progressed through the step-by-step operation of the Vision Express and want to know how to get the most out of their engraver.

It can be challenging to correctly position text and/or graphics. Odd shaped items, which are difficult to measure or locate on the engraving table, pose the biggest problem to most users. The Express has features to help with positioning items and graphics. Two of these features are Setting a Custom Home Position, and using the Jogger and Red Dot Laser Pointer together. Both of these techniques will assist the user when engraving more challenging applications.

### 5.5.1 Setting and Using Custom Home Positions

To set the home position of the machine to the upper left hand corner of the engraving area, place the material (in this example, the cell phone case) on the engraving table and secure it. Press on the jog icon from the home screen.

Press on the magnifying glass to turn the laser on. Jog to the upper left engraving position. Change the offset to 2-8 (1 and 9 are saved for factory home positions). Now press the plus button.

The machine will turn the laser off and move the cutter directly over the new home position. The new home is now saved. Use the green select button to go back to this home position.

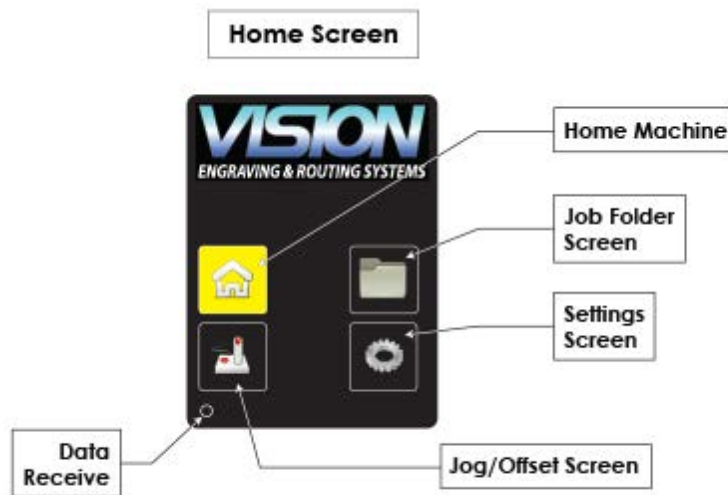

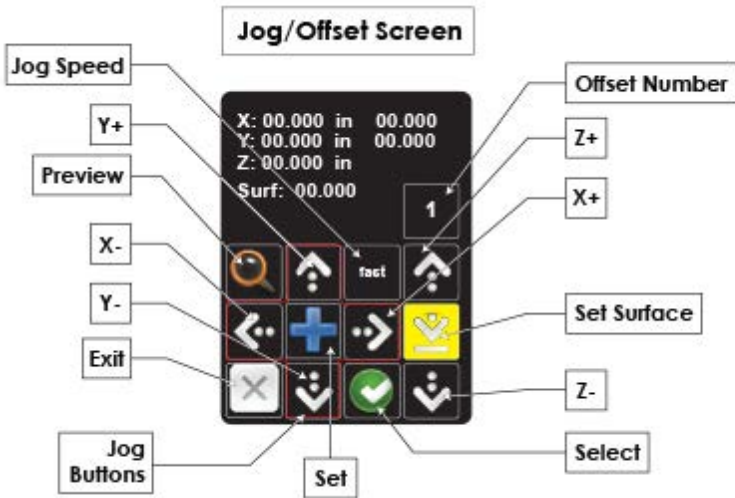

The software defaults to offset #1 (top left corner of engraving table) so we will need to tell it to use this custom home in the software. Go to the Vision 10 software, click on the tool path to be engraved and press the engrave icon.

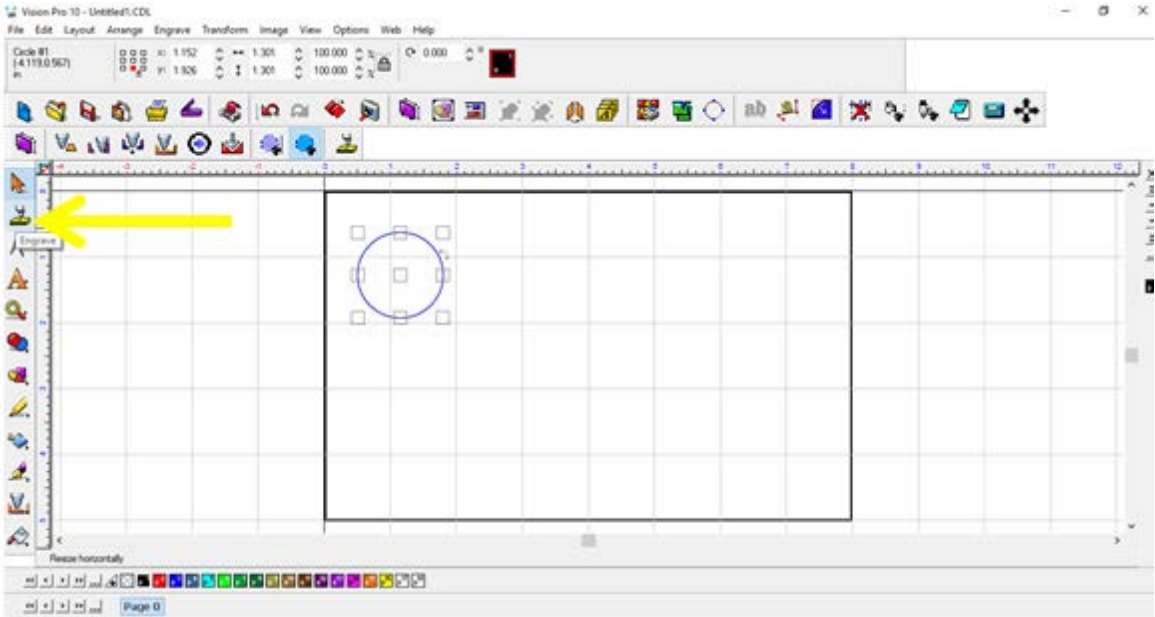

Now press the Tool Setup button

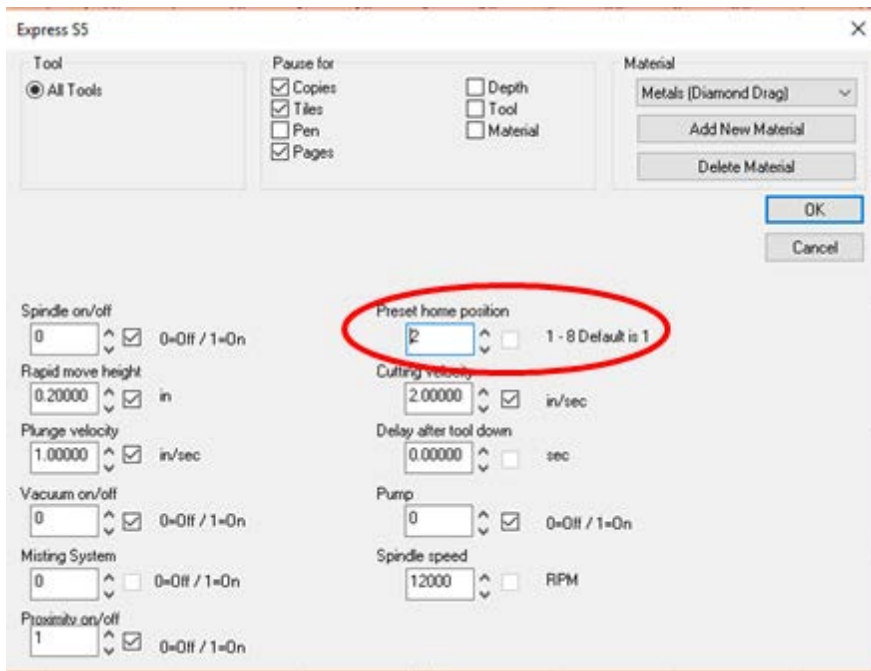
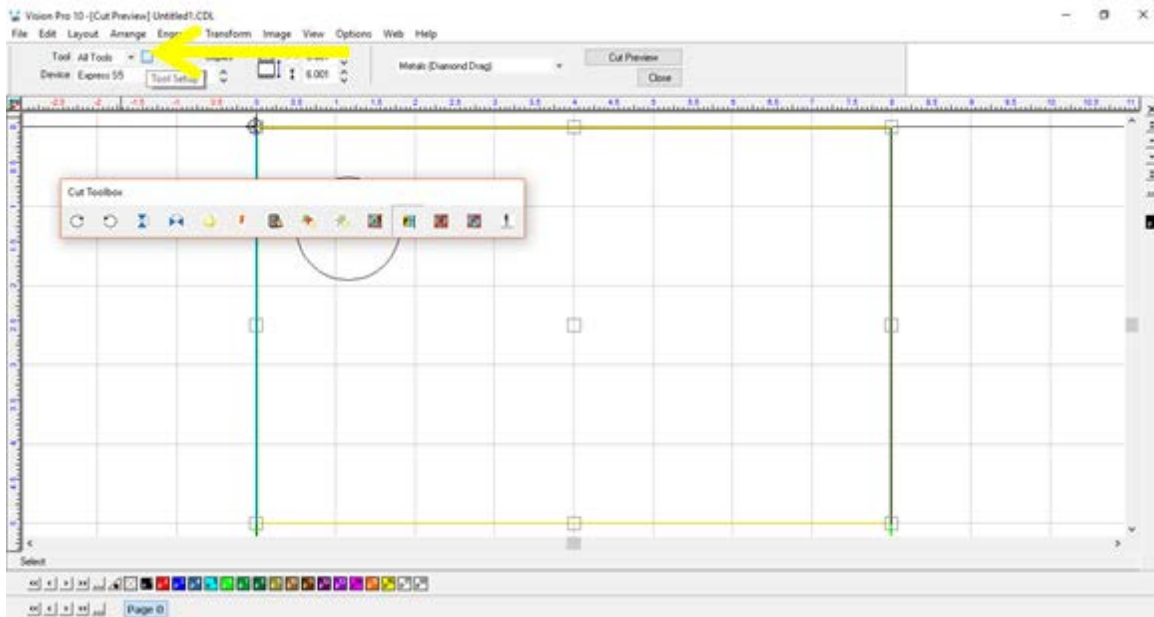

## 5.5.2 Using the Measure Feature

The Measure Feature allows the user to jog to the material and set plate size using the laser feature of the machine.

Open up the vision software and press the plate size icon

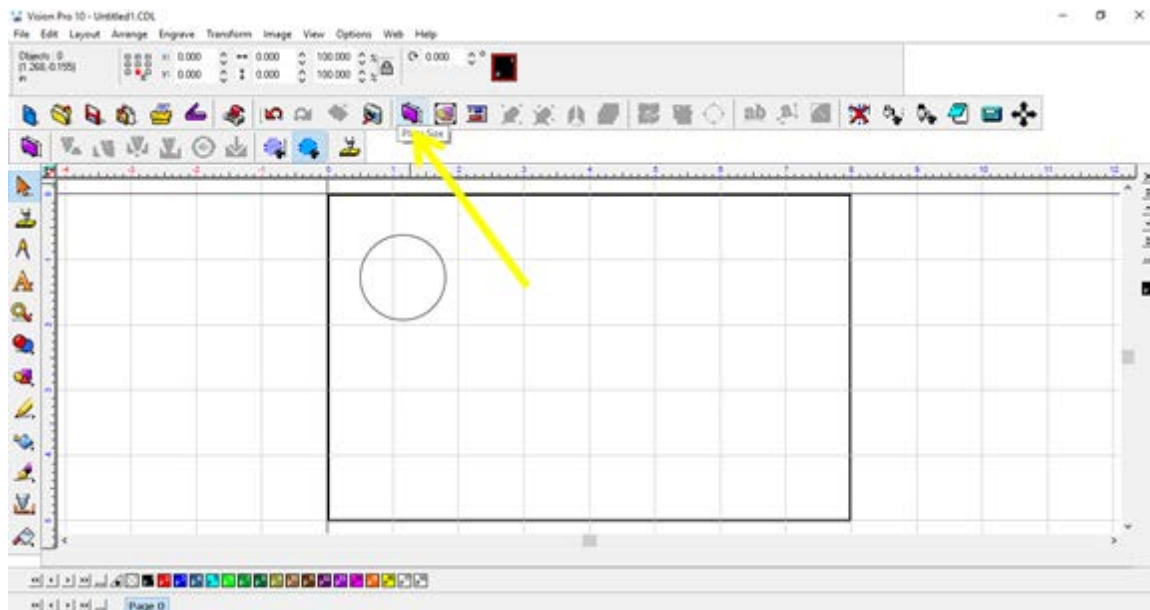

Now press the measure button.

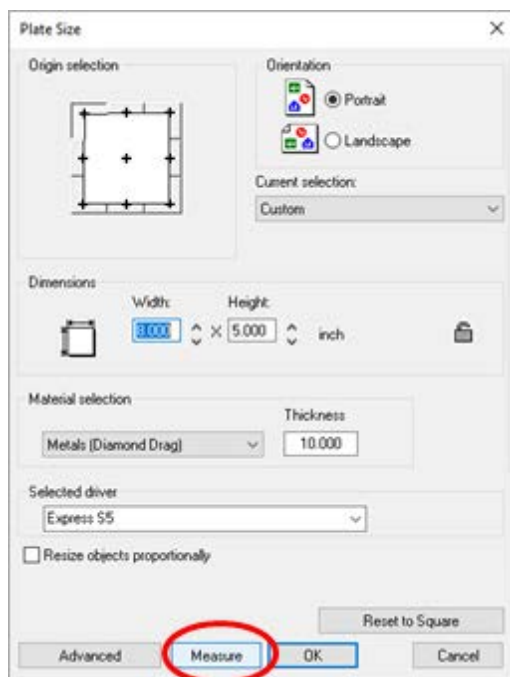

Use the touch panel on the machine to Jog to the top left of the area to be engraved. Press the yellow select button in the middle of the screen, and the yellow background will disappear. Now jog to the bottom right of the area to be engraved and press the green select button.

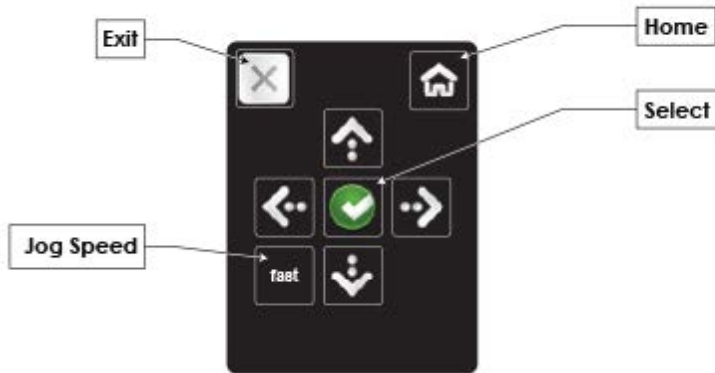
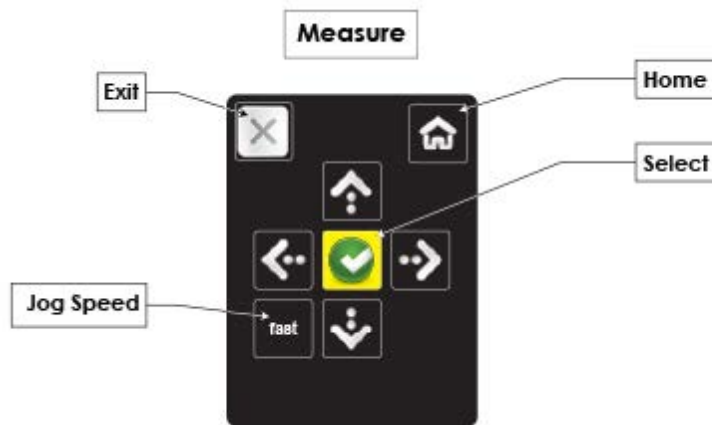

The touchscreen will now show a magnifying glass in the center. Press this to preview the new plate size engraving area using the machines laser.

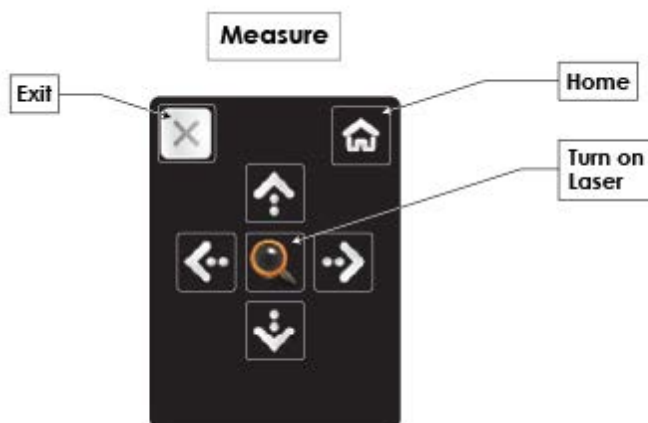



The plate size is automatically resized in the software.

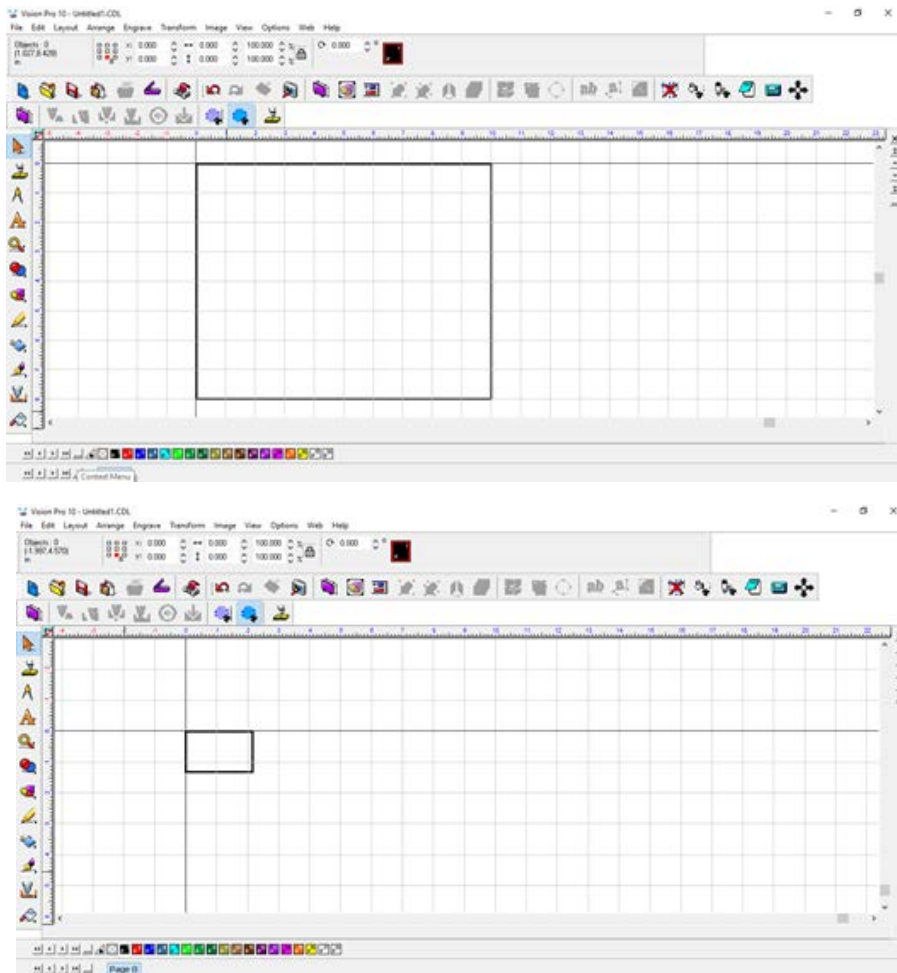

### 5.5.3 Using the Red Dot Laser Pointer for Positioning

A common and easy way to position text and graphics is to use the Red Dot Laser Pointer along with an outline of the area to be engraved in the Vision 10 Software. The Following example will walk the user through the process.

In this example, a 3 inch diameter piece of acrylic will be used and a circular engraving area will be designed. If you are using a rectangular item, the process will be very similar and differences are noted here detailing the variations in the job set up.

First place the material somewhere on the table. (If using a square item make sure it is square to the table edge guides) In this example, multi mat is used to hold down the piece of acrylic. Next install a cutter in the spindle and adjust it so the tool is extending past the nose cone.

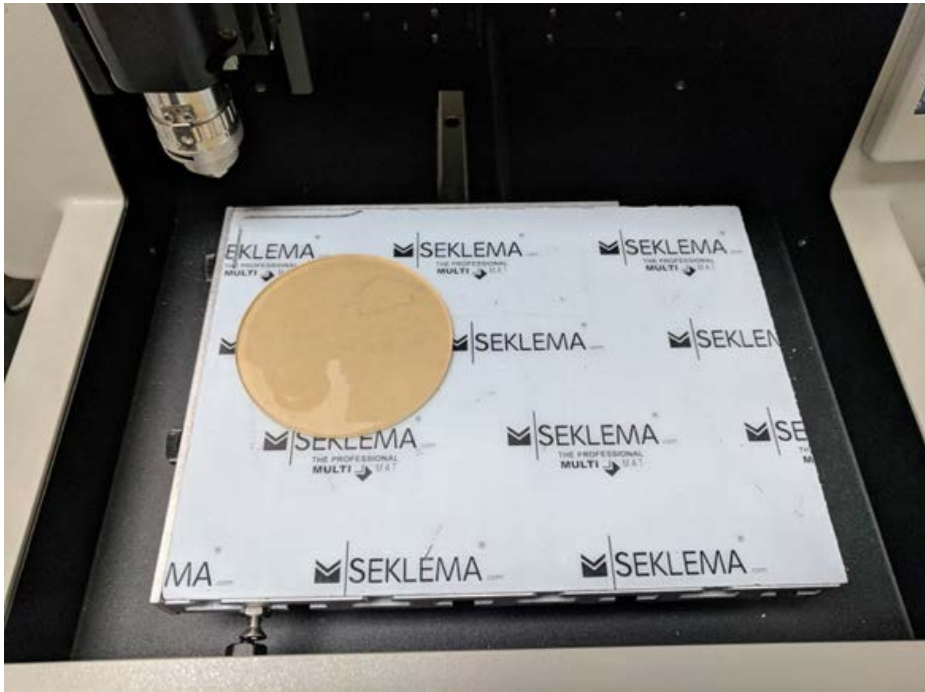

Press the jogger button on the machines touch screen. Now press the magnifying glass to turn on the laser. Use the arrows to jog to the top edge of the piece of acrylic. Write down the Y position readout. (For rectangular items move the laser pointer to the top left corner of your engraving area.



Now Jog to the left most edge of the piece of acrylic. Write down the X position. Repeat moving the spindle to the right and bottom and write down the X/Y positions. (For rectangle objects , you can use the X and Y readouts for the upper left and the lower right corners of your engraving area.

In the Vision 10 software we will now draw guidelines using the measurements we wrote down. To add a guideline, click with the right mouse button anywhere within the plate area. Now select Edit Guides. Select the horizontal guide icon in the top left corner and enter your Y measurement in the Y entry field. Click add and then enter your second Y location. Press add again and then click on the vertical icon in the top left corner of the window. Add both X values that you measured earlier.

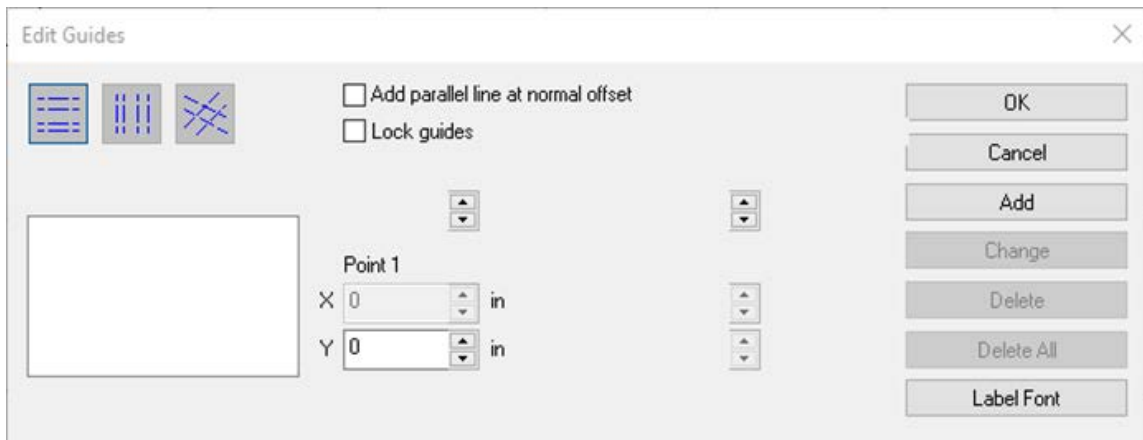

Click Ok when finished. You should now have 4 guidelines as shown here. (Your items engraving area and locations will differ from those shown in this example)

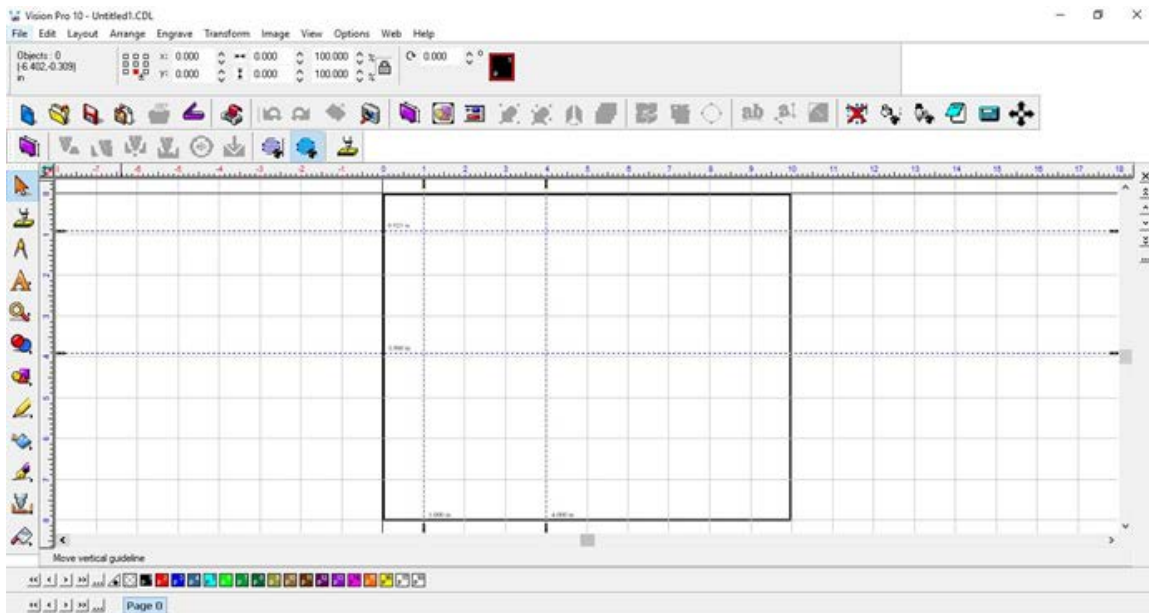

Select the shape tools icon from the left toolbar, and then select the circle tool (or rectangle tool for a rectangle).

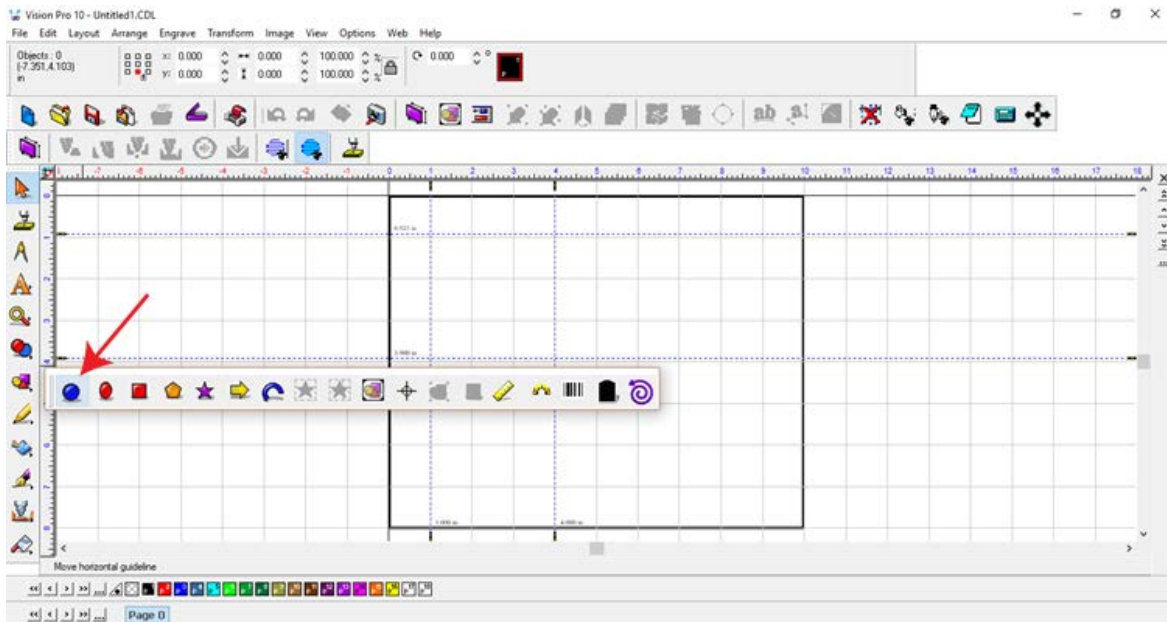

In Order to make sure we will be located properly we will use the machines dry run feature. Send the file to the engraver. Instead of pressing play on the touch screen, press the magnifying glass.

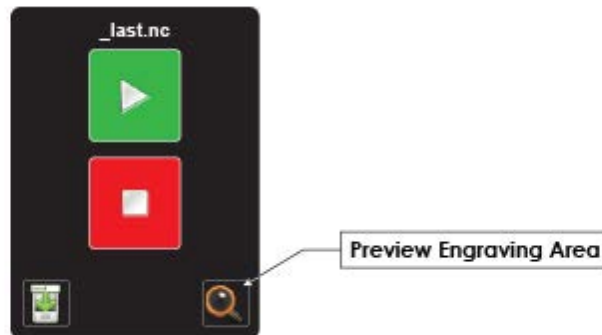

This will turn the laser on and allow us to preview a box around the area that will be engraved.

#### 5.5.4 Creating a Center Driver

In this section, a custom driver will be created based on the Express S5 Vise driver that will allow the user to set a home position in the center of an engraving area. The Vision 10 software will automatically position the job based on this center location. An illustration of this process is shown below.

For simplicity in this example, a circular piece of acrylic will be engraved. The material is 3 inches in diameter, and an engraving area of 1.75" x 0.75" needs to be centered on the piece of acrylic. Referencing the drawing below, the job will be quickly set up using a custom "Center" driver.

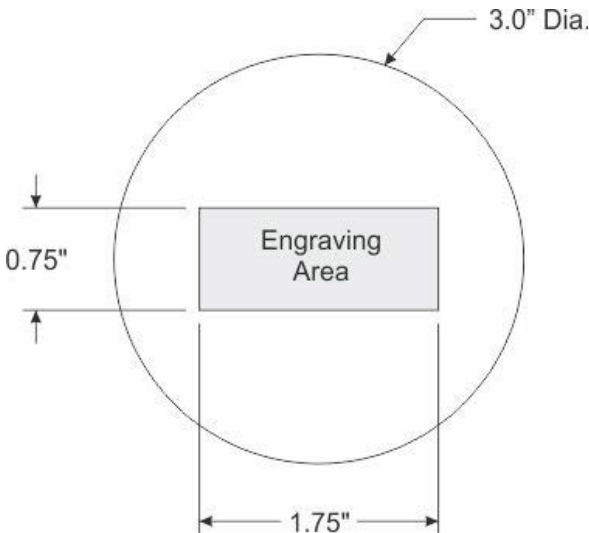

First, we need to create and save a custom Center driver. Open up the Vision 10 software and select Engrave, then Engraving Defaults from the top menu bar.

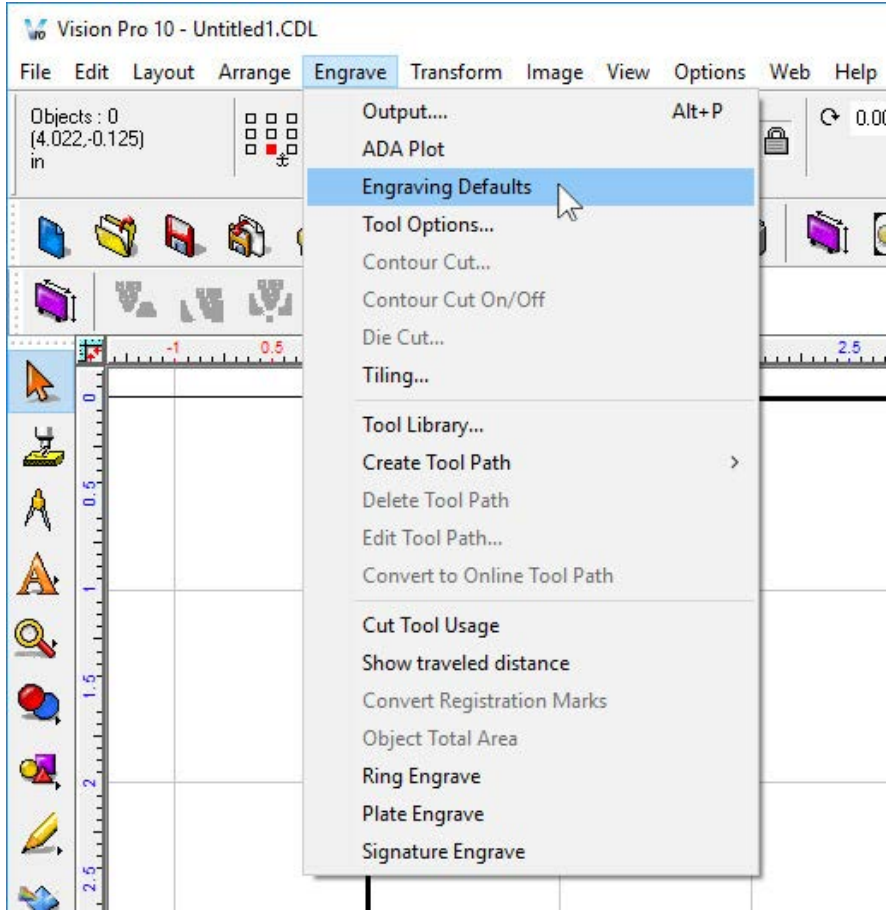

The Plot widow will appear and from the Selected Driver drop down list, select the Express S5 Vice driver.

If this driver has not been installed, refer to the section - Installing Additional Drivers.

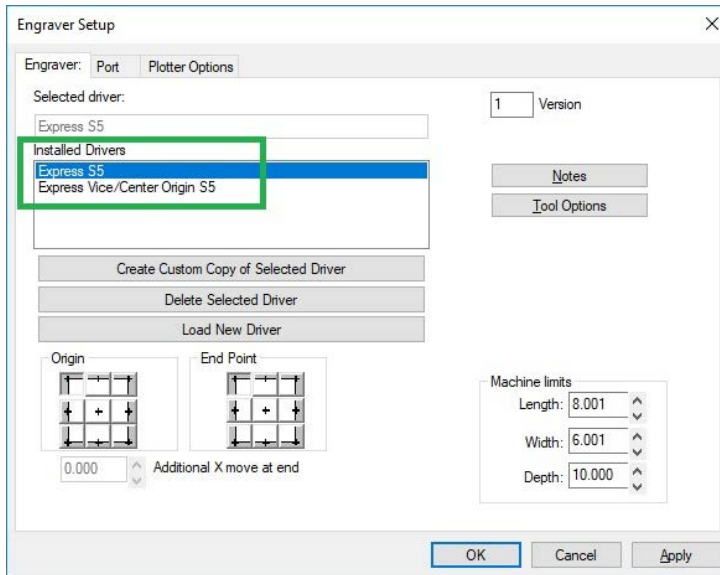

Select Setup.

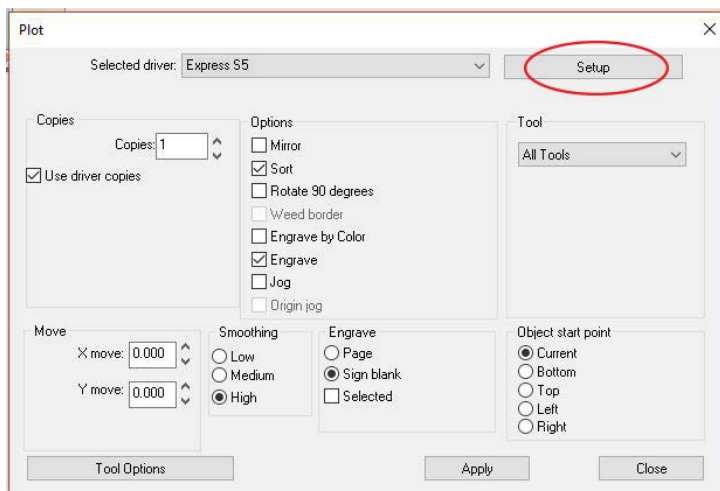

Under the Installed Drivers section, make sure the Express S5 Vise driver is selected, then select Create custom copy of selected driver.

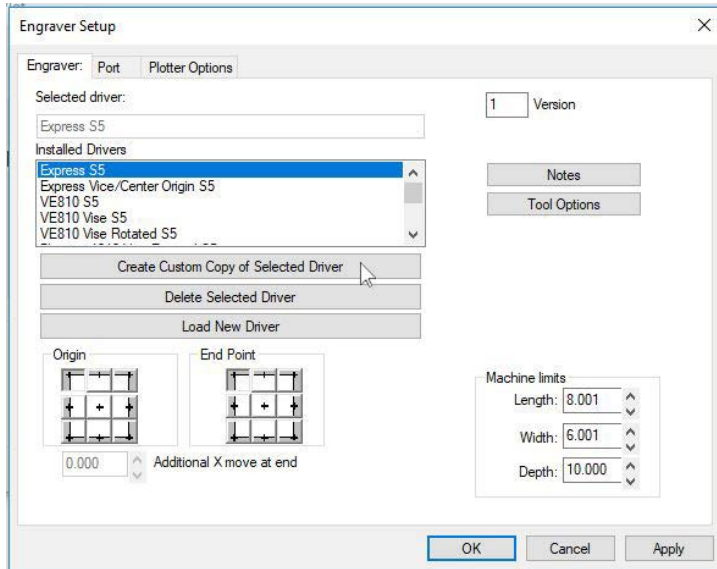

Type in Express Center Driver, then click on OK.

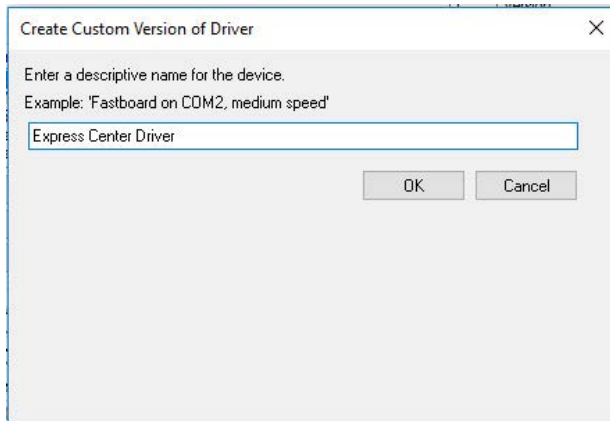



Click on Apply, then click on OK.

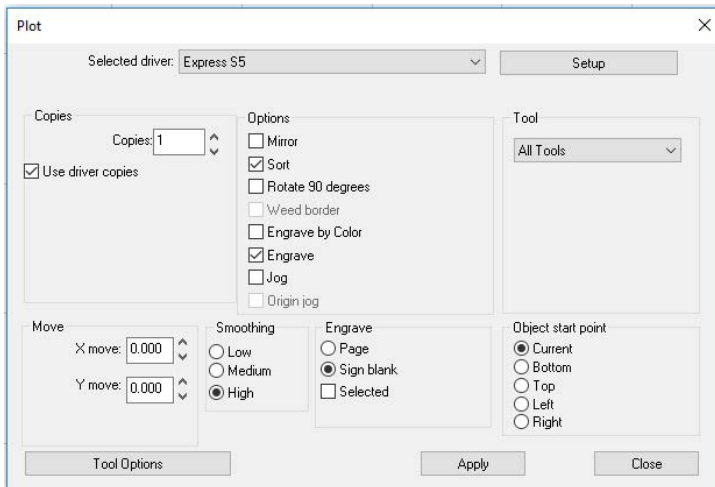

Select the Express Center Driver we just created from the Selected Driver drop down list.

Change the settings in the Move fields to 0 for both X and Y move, click on Apply and then click on Close.

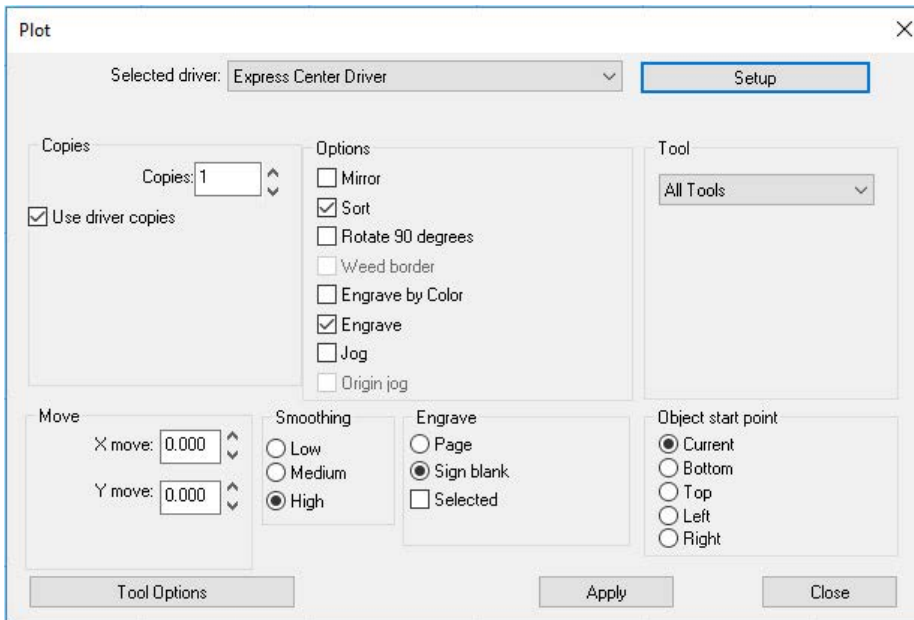



Set the plate size to match the engraving area you determined for your item. In this example, a 1.75" x 0.75" size was entered. Make sure the Selected Driver is the Express Center Driver, then click on OK.

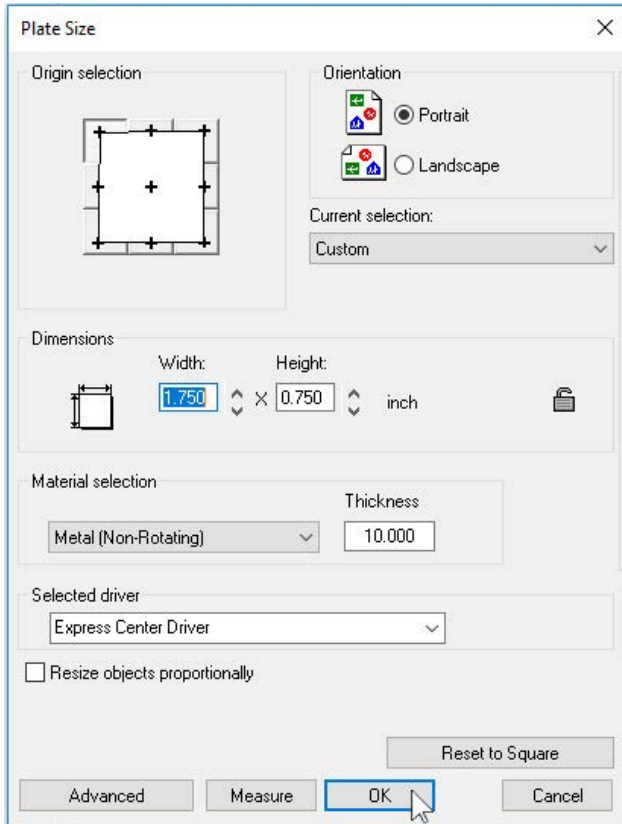

Type in the text or import the graphics you wish to use and center them in the plate.

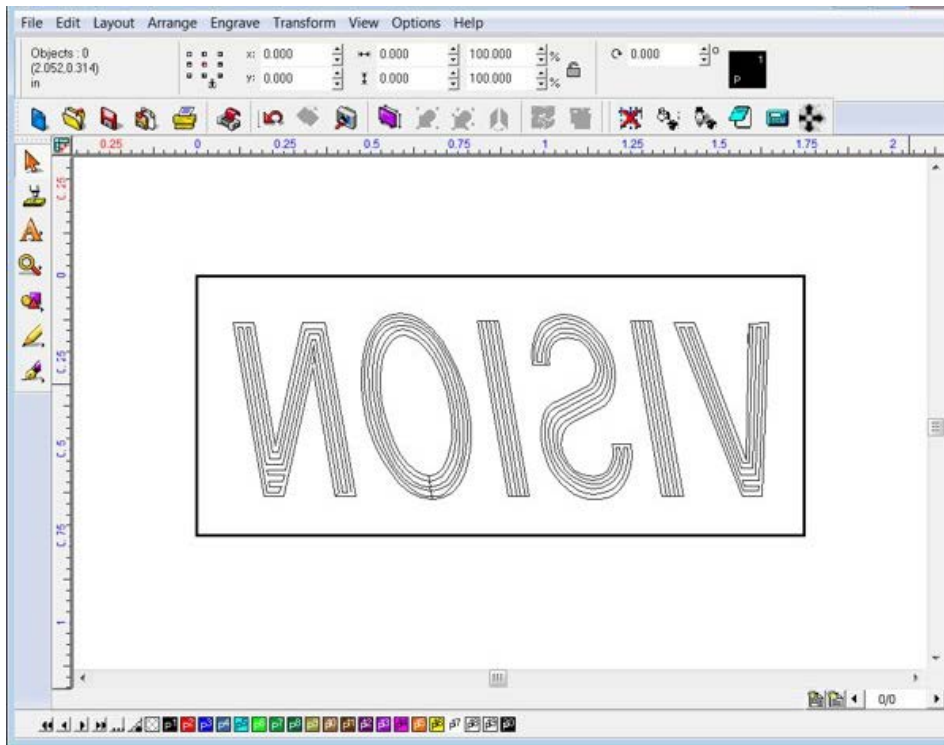

Now, we need to set the home position (set offset) for the item we are engraving. Move the spindle to the center of the engraving area. In this case, it is the center of the 3.0" piece of acrylic. Press the Set Offset button on the engraver. This is now the center of the engraving area for our job. The below picture shows the spindle positioned over the center of the engraving area.

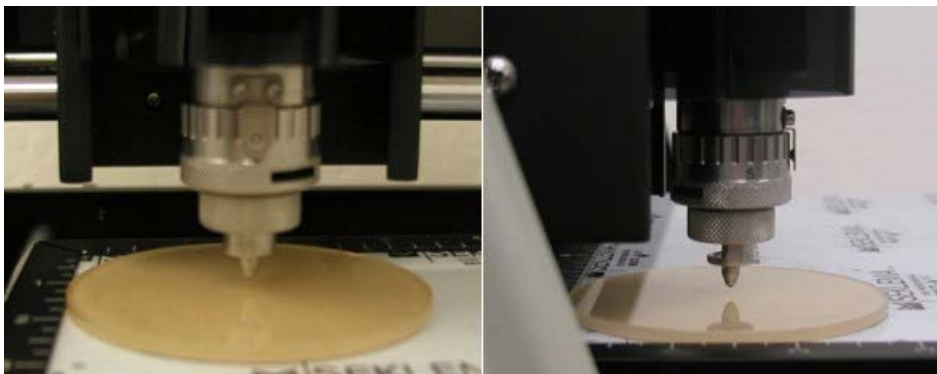

Select the Engrave icon from the left side toolbar. Double check to make sure that the Device is set to the Express S5 Center Driver (on the top toolbar). Choose your material from the Material Setting drop down list on the top toolbar.

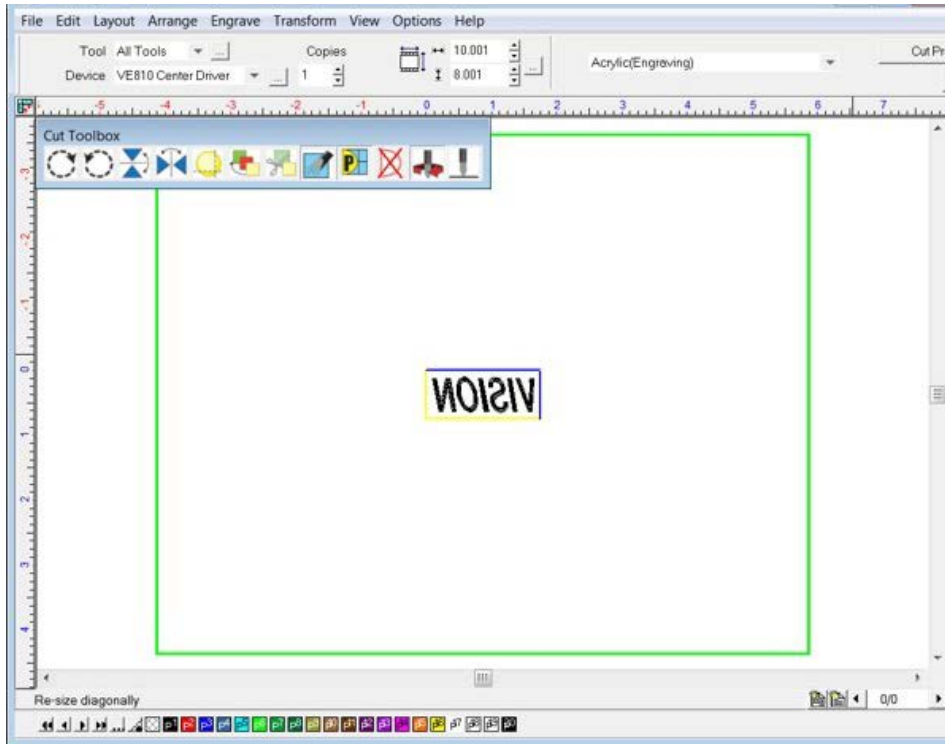

Select Engrave from the Cut Toolbox, then press the Start button on the engraver to begin engraving the job. You may want to perform a dry run before engraving to check for setup errors.

Since we have now created a Center Driver, if we want to use the centering feature in the future, we only need to select the Center Driver from the Device drop down list and set the home position (set offset) on the machine to the center of the engraving area on your item before running the job.



### 5.5.5 Adjusting Spindle Pressure

In some cases, the pressure applied by the spindle (when engraving with the proximity sensor), will need to be adjusted. Behind the spindle, there is a Spindle Pressure Spring Adjustment knob that can be turned to increase or decrease the amount of pressure. The pictures below show the location of this knob.

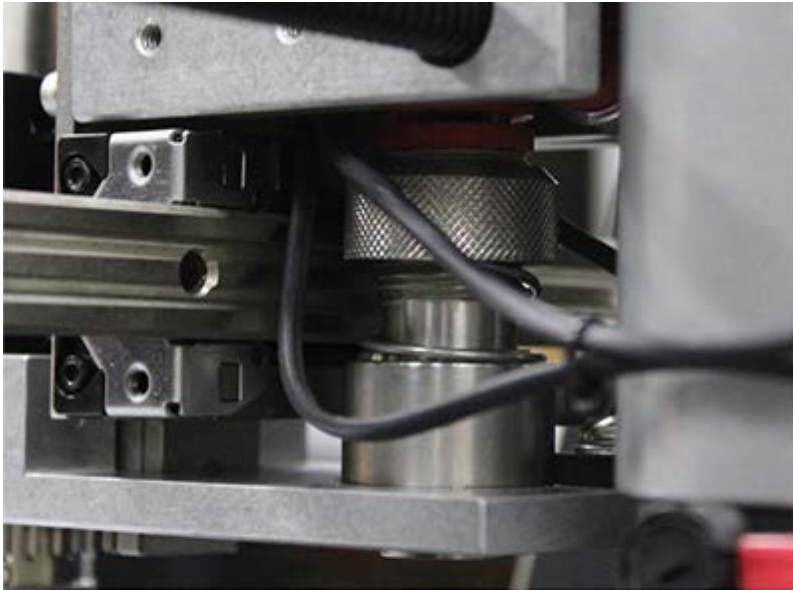

**Spindle pressure spring adjustment knob  
(Shown in upper position - least pressure)**

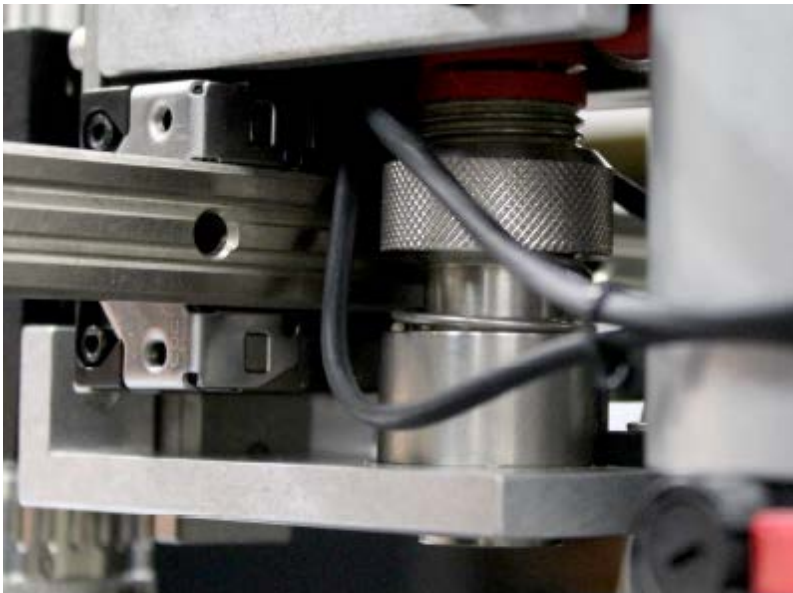

**Spindle pressure spring adjustment knob  
(Shown in mid position - medium pressure)**

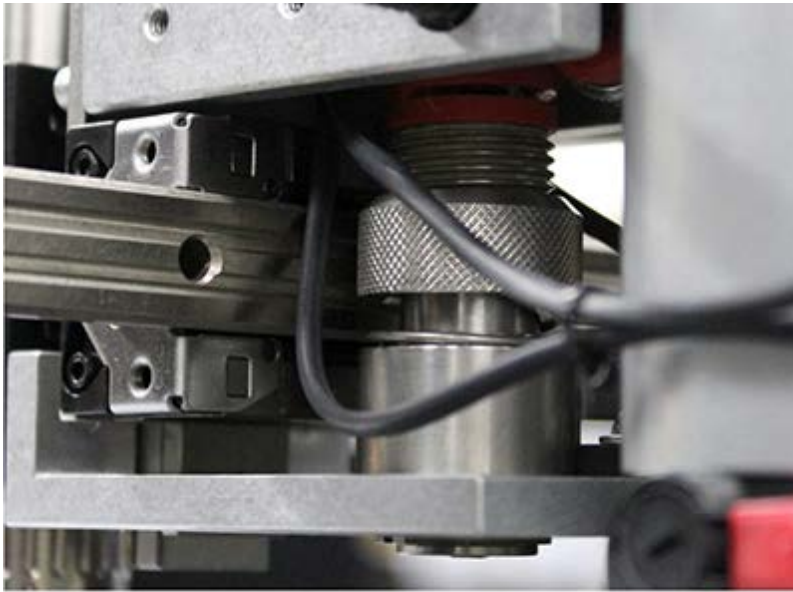

**Spindle pressure spring adjustment knob  
(Shown in lower position - most pressure)**

To change the engraving pressure, the knob must be rotated, which changes the preload on the spring, and therefore the amount of pressure applied by the cutter tip on to your material. This is normally performed for diamond drag engraving only. More pressure will produce a deeper engraving.

To increase the engraving pressure, the knob must be rotated clockwise (when viewed from the top of the machine). In order to access this knob and turn it, turn the machine off, then press on the top of the spindle to lower the spindle to its bottom position.

Reach under the spindle assembly as shown. Turn the knob clockwise to increase pressure and counterclockwise to decrease pressure.

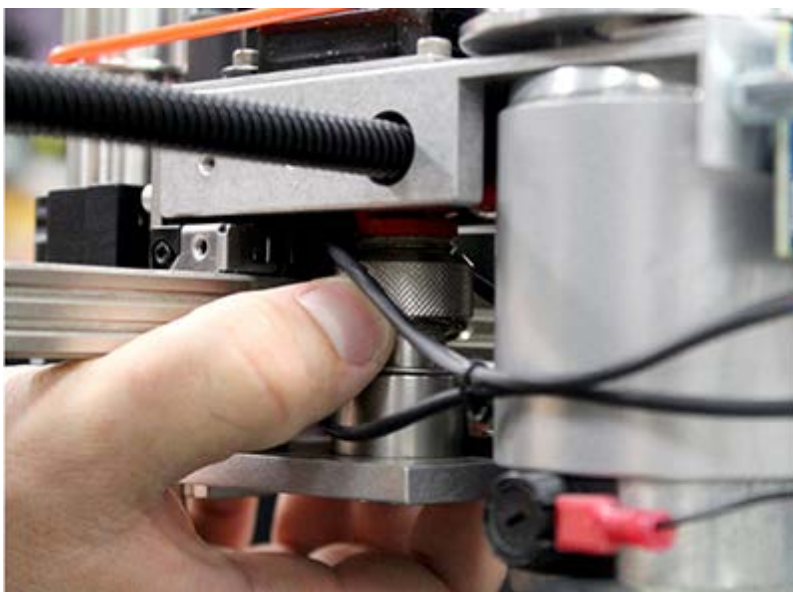



## 5.5.6 Installing Additional Drivers

If you need to install additional drivers, such as the Express S5 Vise driver or for another machine, in the Vision 10 software, select File from the top menu bar, then select Install and click on Cutting Devices.

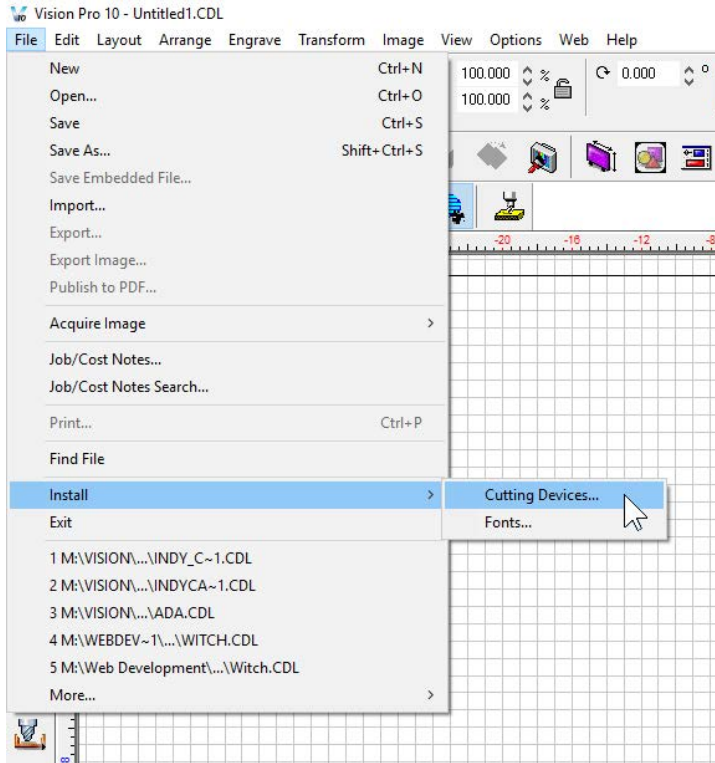

The Installation Wizard will begin.

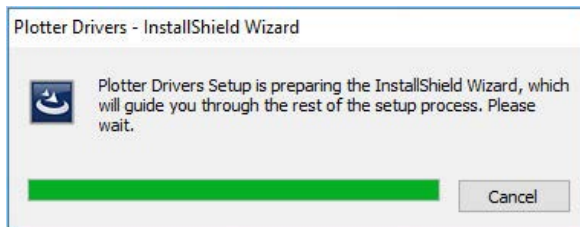

The Driver Installation Wizard window will appear. Select the machine series from the Manufacturer list on the left side by placing a check mark in the box of the machine you wish to use the driver for, then select the driver(s) by placing a check mark in the box to the left of the driver(s) you wish to install. Click on Next to install the driver(s).



Cutting Device Installation

Manufacturer:

Select or remove one or more cutting device manufacturers.

|                                     |                                       |      |
|-------------------------------------|---------------------------------------|------|
| <input checked="" type="checkbox"/> | Vision Express S5                     | 48 K |
| <input type="checkbox"/>            | Vision Express S4                     | 0 K  |
| <input type="checkbox"/>            | Vision Engravers S4                   | 0 K  |
| <input type="checkbox"/>            | Vision VE810 S5                       | 0 K  |
| <input type="checkbox"/>            | Vision VE810 S4                       | 0 K  |
| <input type="checkbox"/>            | Vision Max S4                         | 0 K  |
| <input type="checkbox"/>            | Vision MaxPro S4                      | 0 K  |
| <input type="checkbox"/>            | Vision Routers S4 (2'x4' and smaller) | 0 K  |
| <input type="checkbox"/>            | Vision Routers S4 (4'x8' and larger)  | 0 K  |
| <input type="checkbox"/>            | Vision Engravers S3                   | 0 K  |
| <input type="checkbox"/>            | Vision Max S3                         | 0 K  |
| <input type="checkbox"/>            | Vision MaxPro S3                      | 0 K  |
| <input type="checkbox"/>            | Vision VE810 S3                       | 0 K  |
| <input type="checkbox"/>            | Vision Routers S3 (2'x4' and smaller) | 0 K  |
| <input type="checkbox"/>            | Vision Routers S3 (4'x8' and larger)  | 0 K  |
| <input type="checkbox"/>            | Vision Engravers S1 and S2            | 0 K  |
| <input type="checkbox"/>            | Vision VE810 S1 and S2 (no LCD)       | 0 K  |

InstallShield

&lt; Back

Next &gt;

Cancel

Cutting Device Installation

Manufacturer: Vision Express S5

Select the drivers you want to install, clear the drivers you want to uninstall.

|                                     |                                      |      |
|-------------------------------------|--------------------------------------|------|
| <input checked="" type="checkbox"/> | Vision Express S5                    | 24 K |
| <input type="checkbox"/>            | Vision Express Vice/Center Origin S5 | 0 K  |

InstallShield

&lt; Back

Next &gt;

Cancel



The installation will proceed and the below window will appear briefly. When this window closes automatically, the driver(s) will then be available in the Device drop down list.

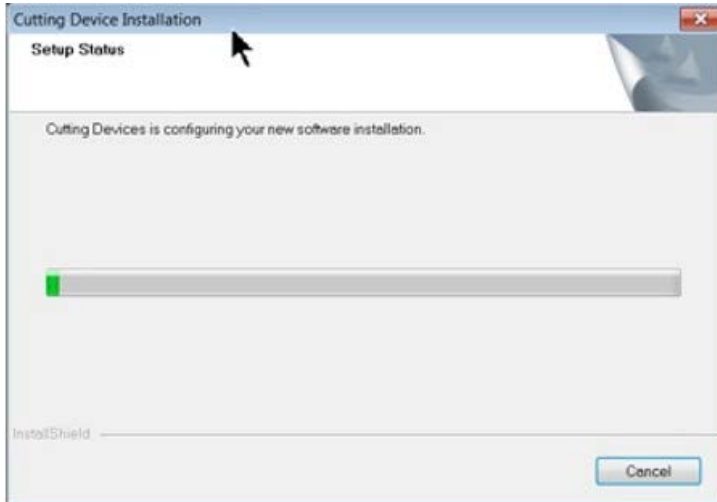

If you wish to uninstall driver(s), simply follow the above procedure, and deselect the drivers by removing the check mark to the left of the machines you want to uninstall from the Manufacturer section of the Driver Installation Wizard window, then click on Next to remove those drivers.

## 6 Maintenance

**Vision strives for the highest quality in their manufacturing process to provide you with the most cost effective, reliable engraving machine in use today. Please remember that proper maintenance and care is necessary to achieve maximum product life expectancy.**

The engraving environment generates small plastic and metal chips as well as other particles during operation. As with any machinery, your engraving system should be kept as clean as possible to minimize wear and tear, and improve final quality of the engraved product.

### 6.1 Multi Mat Information

#### **How long will Multi Mat last?**

The life span of Multi Mat depends on many factors, including type of use, proper cleaning and handling. One great advantage is that it is double sided, thereby providing double the life span when compared to other single sided products.

#### **What is the cleaning procedure of Multi Mat?**

Cleaning Multi Mat is simple and easy. Merely use a soft sponge and running water to remove chips, dust, or dirt, and then allow to dry. No chemicals or cleaners are required.

#### **How is Multi Mat affixed to the engraving table top?**

No double stick tape, vacuums, or clamps are necessary. Multi Mat can be easily removed and stored, then reinstalled by placing it in position and gently pressing down. No other hold down system is so fast and easy to use.

#### **Is there any clean up required after using Multi Mat?**

For most situations the answer is no. However, Multi Mat does leave a slight residue on the back of some engraving plates.

#### **What happens if I engrave through the engraving material into Multi Mat? Is it ruined?**

Multi Mat has a self healing feature. Small cuts in the surface of Multi Mat should not cause a problem and seem to heal. Of course, continued cuts over a long period of time will degrade the effectiveness of Multi Mat. Many small enclosed cuts (closed path such as a series of circles or squares) could cause sections of the mat to come out, which of course would degrade its performance.

### 6.2 Cleaning

#### **Chip Removal**

Plastic and metal chips generated during the engraving process should be removed from the engraving surface periodically. A portable vacuum is suggested for chip removal, but applying direct suction to the spindle area is not recommended. Note that this cleaning can be minimized and greatly simplified through the use of the optional vacuum chip removal system. The vacuum chip removal system removes chips and dust created by engraving. This system can also extend the life of other components in the system, as prompt removal of chips reduces contamination and overheating in the spindle area. The vacuum chip removal system also keeps the nose cone from skipping over letters when chips become trapped between the nose cone and the engraving material.

#### **Cleaning The Nose Cone**

The nose cone around the cutter may accumulate dust and chips that cannot be removed by vacuuming or blowing on them with low pressure air. CAUTION! High pressure air can damage the spindle. Two

---

types of nose cones are available; one nose cone is designed to be used with the vacuum system, the other is not. Cleaning methods depend on the type of nose cone in use.

With a vacuum chip removal system, most of the chips will be removed during the engraving process. If the suction nozzle becomes clogged, remove the hose connection to the nose cone. Remove the cutter, then unscrew the vacuum nose cone. Using a vacuum or an air hose, clean out the nose and the vacuum tube leading to the nose cone. Reinstall the nose cone and the vacuum hose.

Without a vacuum chip removal system you should remove the cutter before attempting to clean the nose cone. The nose cone retainer ring, the nose cone, and the micrometer collar should all be removed and cleaned using a vacuum or compressed air. The three nose cone components should be removed and cleaned at least every day, or as frequently as necessary. Failure to clean the nose cone regularly will result in premature spindle failure.

#### **Vacuum Maintenance (only with the vacuum chip removal option)**

When you notice a significant drop in suction, the filter bag needs to be changed. Do not clean the filter bag as this will result in a tear. To replace filter bag, remove the 6 screws on top cover of the unit. Slide the bag inlet off the inlet pipe. Vacuum out any dust at the base prior to re-installing the bag, to ensure the life of the motor. Re-install the new filter bag into the top cap of unit and fasten to bottom casing. If proper suction doesn't return after replacing the filter bag, then the HEPA filter needs to be replaced.

## 6.3 Motion System Cleaning & Lubrication

### Materials Needed

3-in-1 oil  
Teflon-free Silicon Spray  
Allen Wrench Set  
Paper Towels  
Isopropyl Alcohol

### Procedure

Portions of this procedure are illustrated with the top cover installed. Although it is not necessary to remove the cover for cleaning and lubrication, it will make access to the various motion system components much easier.

### Spindle Cover Removal

To remove the spindle cover, slide the cover up. Squeezing the sides of the cover will facilitate removal.

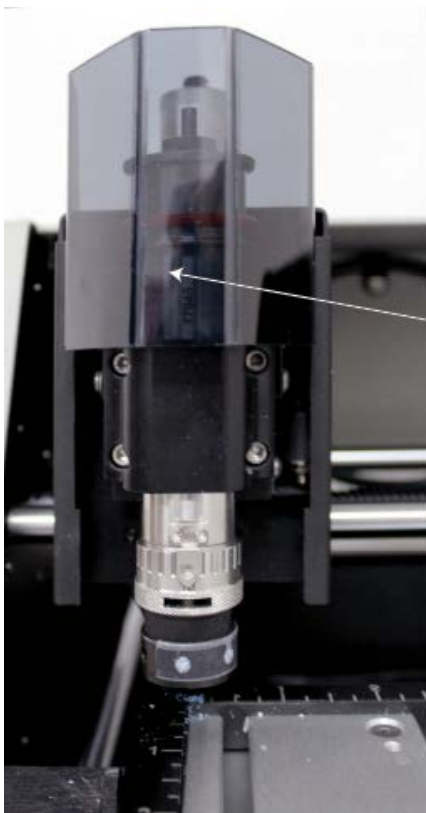

**Spindle Cover  
(Shown Partially  
Removed)**

### Top Cover Removal

Power off the machine, remove the power cable and network plug from the rear of the machine. Remove the 2 Allen Screws on the left side and 2 on the right side of the top cover. Slide the top cover up and back to remove it from the machine.

*HINT: Pressing outward on the inside walls of the machine's frame may facilitate in cover removal.*

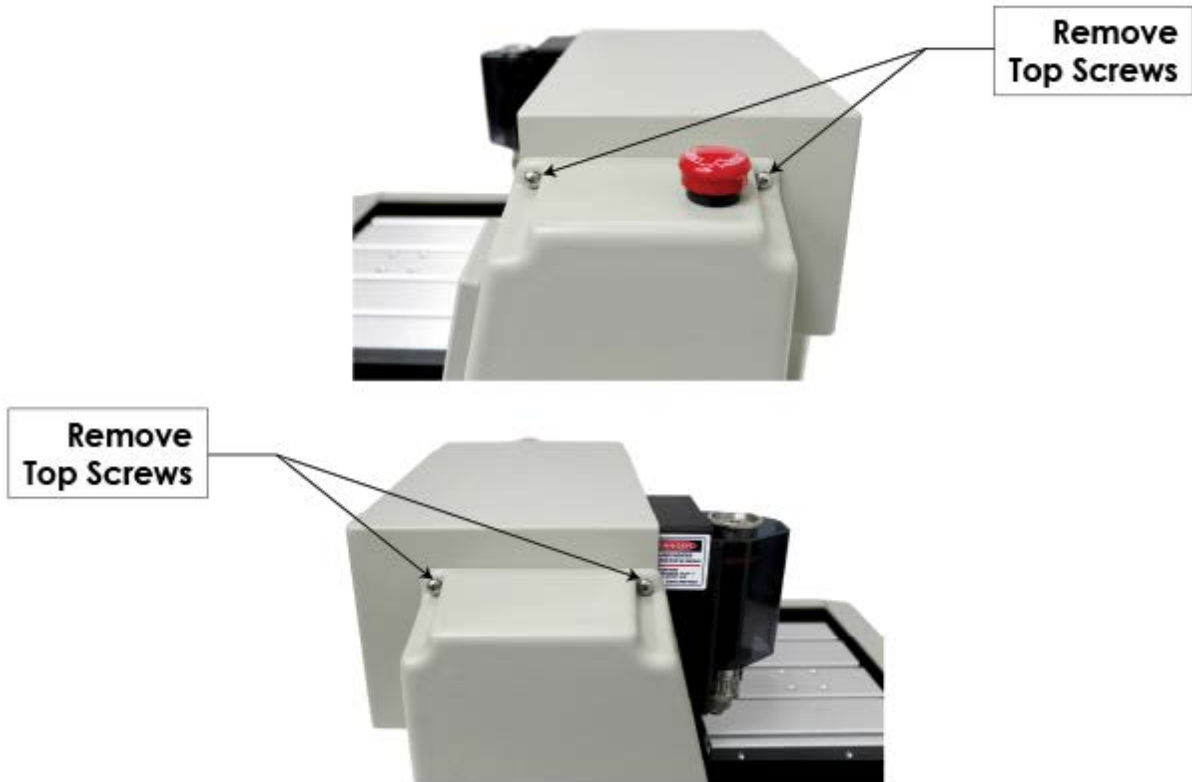

## Cleaning

**NOTE:** With the machine **POWERED OFF**, you can move the carriage, table and spindle manually to access areas for cleaning and lubricating the machine. To move the table, press on the front or rear edge. To move the carriage, press on the left or right side of the carriage cover. To move the Spindle, press on the top of the Spindle to move the Spindle down and press on the bottom of the Spindle to move it up.

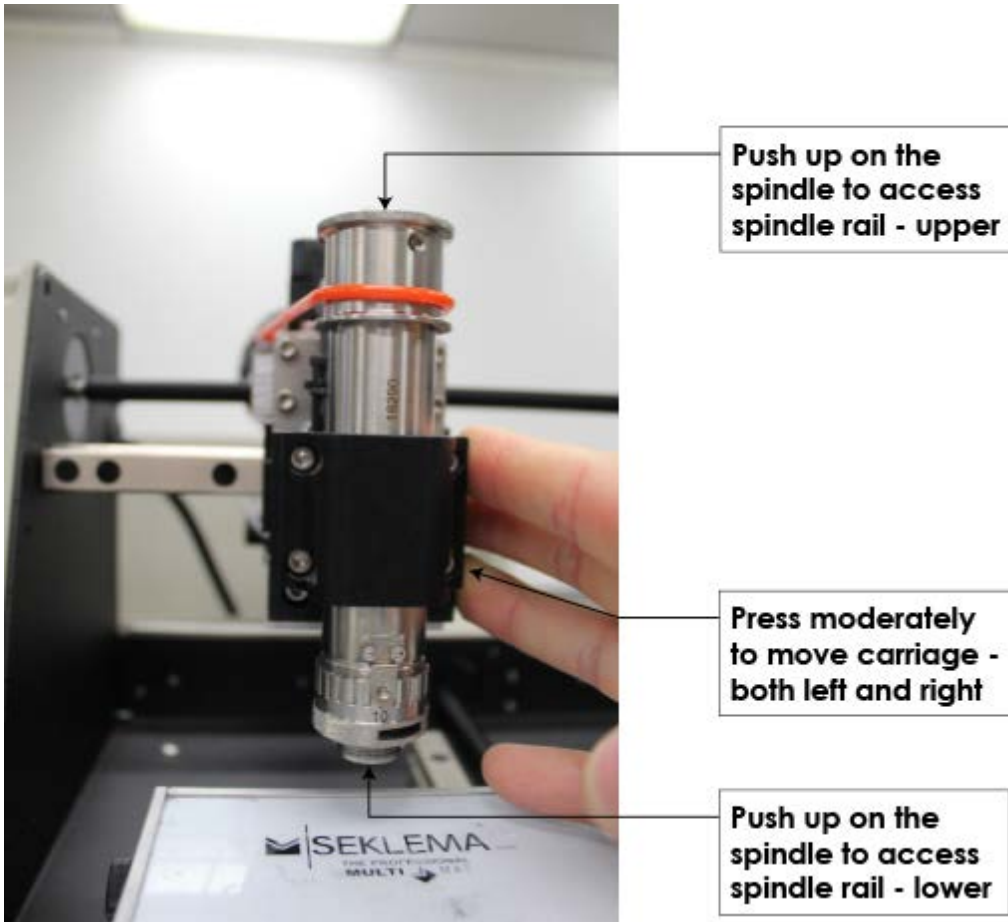

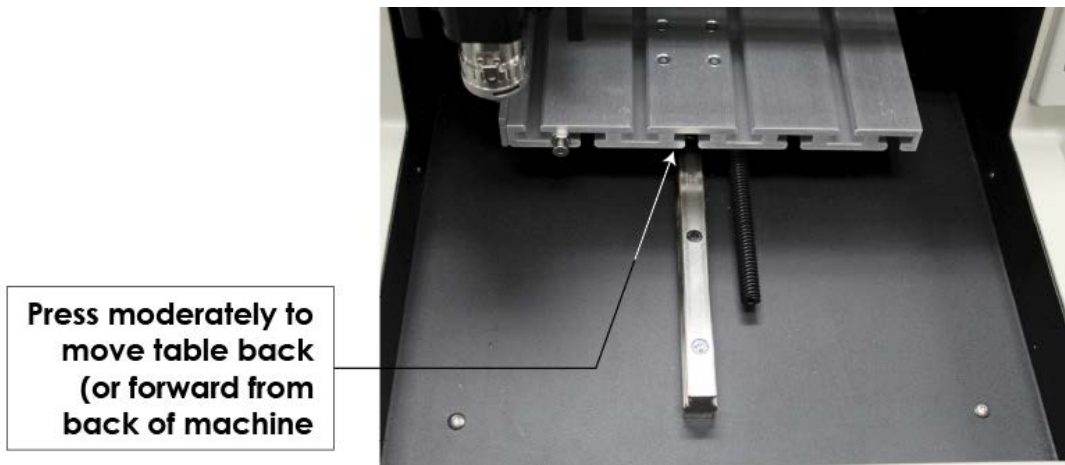

Apply isopropyl alcohol to a paper towel and wipe down the X-Axis (carriage) leadscrew and the stainless steel rail for the carriage. Move the carriage and spindle to access all areas of the leadscrew and rail.

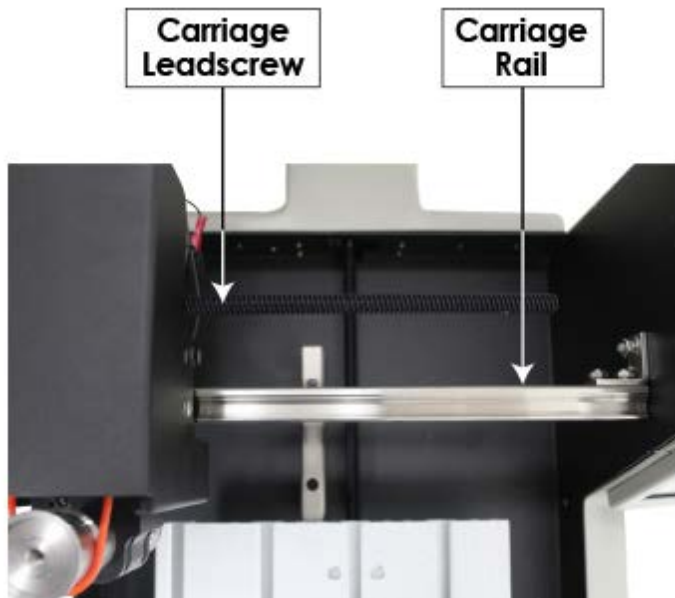

Apply isopropyl alcohol to a paper towel and wipe down the leadscrew and the stainless steel rail for the t-slot table.

**NOTE:** Clean the leadscrew, rail and baseplate (the area underneath the table) with the table in the fully extended (forward) and fully retracted positions.

Table in Forward  
Position (Viewed from  
rear of machine)

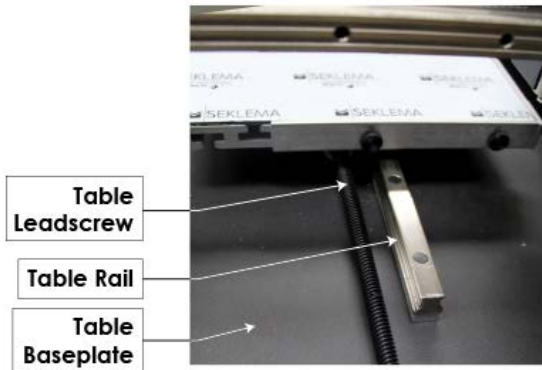
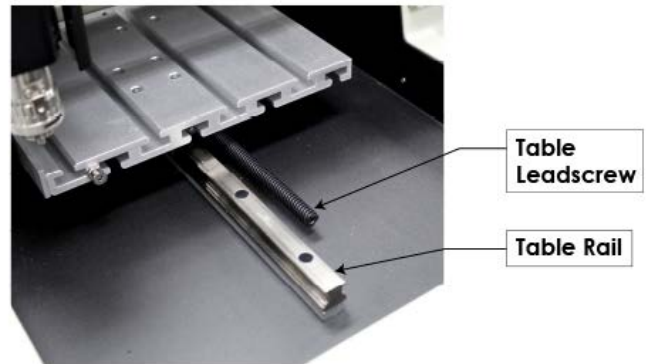

Table in Rearward Position





Lower the spindle down to access the upper sections of the spindle rail. The rail is located behind the spindle. Apply isopropyl alcohol to a paper towel and wipe down the sides and front of the spindle rail. Then raise the spindle and wipe down the lower portions of the spindle rail.

**Spindle Rail  
Upper**



**Spindle Rail  
Lower**

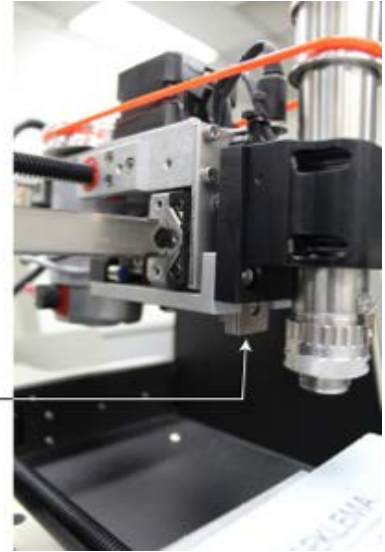

**NOTE:** The Z-Axis leadscrew is protected from debris by the carriage cover and is less likely to become contaminated by debris. It will require periodic cleaning and lubrication. To access the Z-Axis leadscrew, remove the top cover and the carriage cover, then lower the spindle. This will expose the leadscrew, which is located between the spindle and the motor.



Carriage Cover Screws

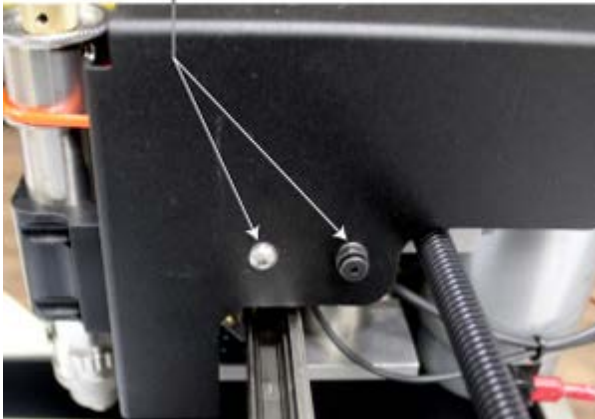

In the below picture showing the Z-Axis leadscrew, both the top cover and the carriage cover have been removed.



**Z-Axis Leadscrew -  
(View from Back/Left  
Corner of Machine)**

## Lubrication

### X&Y-Axis Linear Rails

Apply 2-3 drops of a light oil (such as 3-in-1 oil) on the rails and spread it evenly with your fingers.

### X-Y-Z-Axis lead screws

A light lubrication of the X, Y and Z-Axis leadscrews should be performed periodically. At a minimum, lubrication should be performed every 6 months, although if applications that produce large amounts of debris are run (such as wood or plastic engraving), cleaning and lubrication should be performed more often. Use Teflon-free silicone lubricant only on the leadscrews. **DO NOT** use any lubricant other than Teflon-free silicone spray, as it may attract debris and create a buildup that can cause mechanical failure.

**NOTE:** Place a paper towel underneath the leadscrews to prevent over spray as shown below.



### Working in the lubricants

After completing this procedure and re-installing the carriage and top covers, the lubricants should be worked in to the motion system for several minutes prior to using the machine. To move the motion system, use the Jogger function from the Vision software, moving the carriage, table and spindle through their range of motion to evenly distribute the oil.

### What not to lubricate

Many of the bearings and assemblies in your engraving machine are sealed and/or coated using special low-friction methods and should not be lubricated.

**DO NOT** attempt to lubricate the spindle or the spindle bearings. This will attract particles and dust, which will build up between the shaft and sleeve and possibly prevent movement. If you suspect lubrication problems, call your dealer/representative or the service department at Vision.

**DO NOT** oil the X or Y stepper motors. None of the motors on the Vision Express require lubrication. Oiling the stepper motors can permanently damage them.

**DO NOT** use any type of grease product to lubricate this machine.

## 6.4 Changing the Motor Belt

In order to change the motor belt, it is recommended to remove the spindle cover, top cover and the carriage cover. Power off the machine, slide the spindle cover up and remove. Remove the top cover screws and top cover, then remove the carriage cover screws and carriage cover.

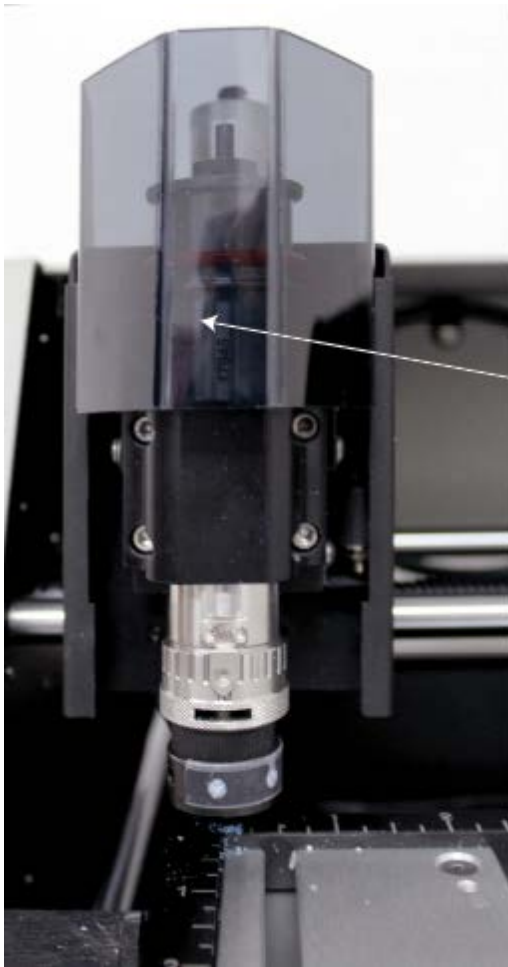

**Spindle Cover  
(Shown Partially  
Removed)**

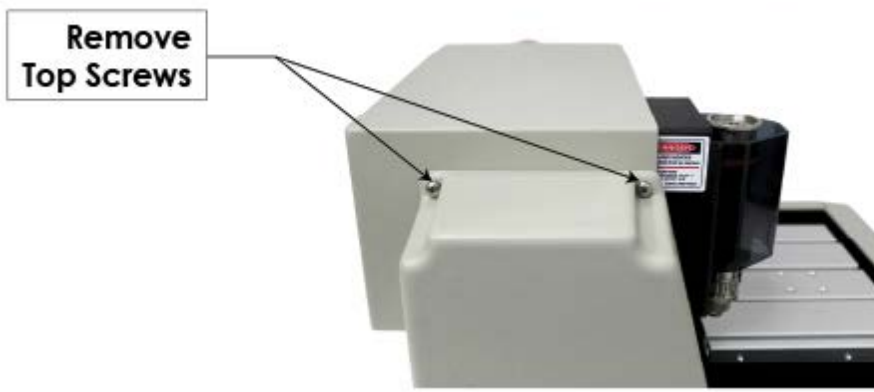



Carriage Cover Screws

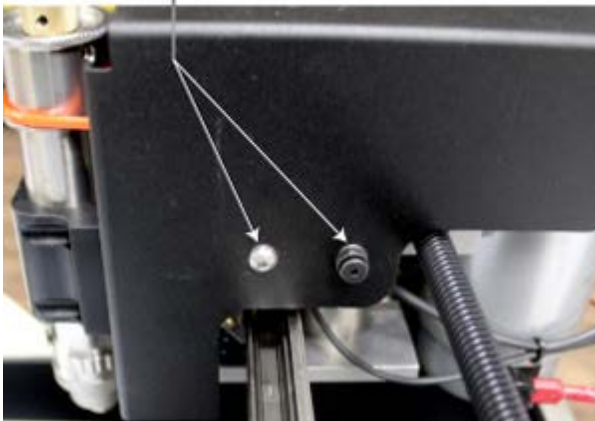

To remove the motor belt, roll the front edge of the belt up and over the top of the spindle.

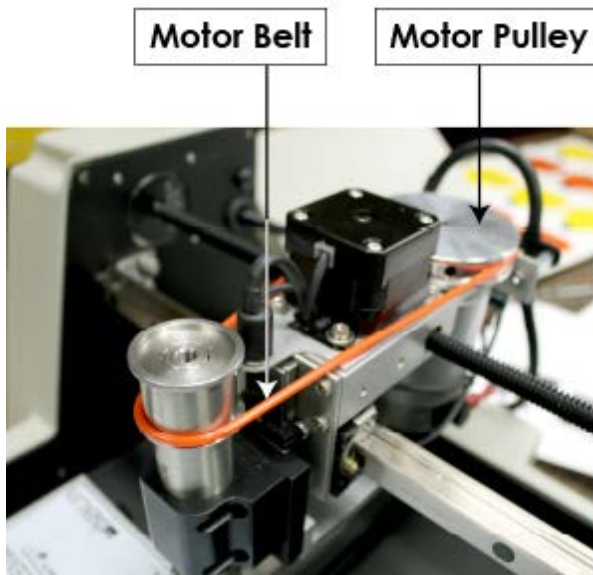

To install the new belt, position the belt in the groove of the motor pulley and pull the belt toward the top of the spindle. It will help to pull the belt forward and roll the front portion of the belt downward when stretching it over the top of the spindle. Once the belt is in place, rotate the spindle by hand a few times to check for binding and to make sure the belt is properly installed. Re-install the covers.



## 6.5 Changing the Motor Brushes

Motor brushes are a wear item on the engraver and will eventually require replacement. Motor brushes experience wear during rotary engraving or cutting operations. The life of the motor brushes will depend on the usage of the machine and they will typically last for several years.

**NOTE: Unplug the machine from its power source before attempting this procedure. Failure to unplug the machine could present an electrical shock hazard.**

To easily access the motor brushes for removal, it is recommended to remove the top cover and carriage cover as described in the previous section.

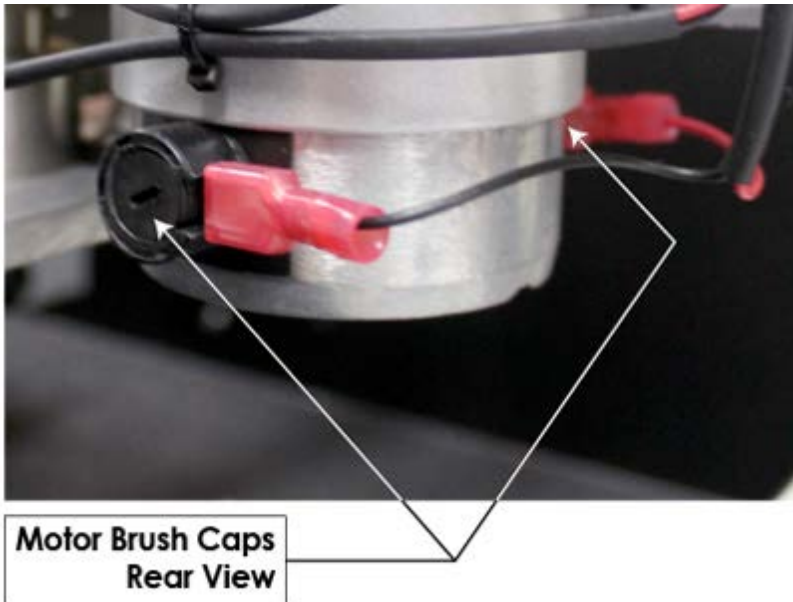

Use a flat blade screwdriver to loosen the motor brush caps. Inspect the motor brush for length. If the length is under 1/8th inch (3.2 mm), the motor brush needs to be replaced.

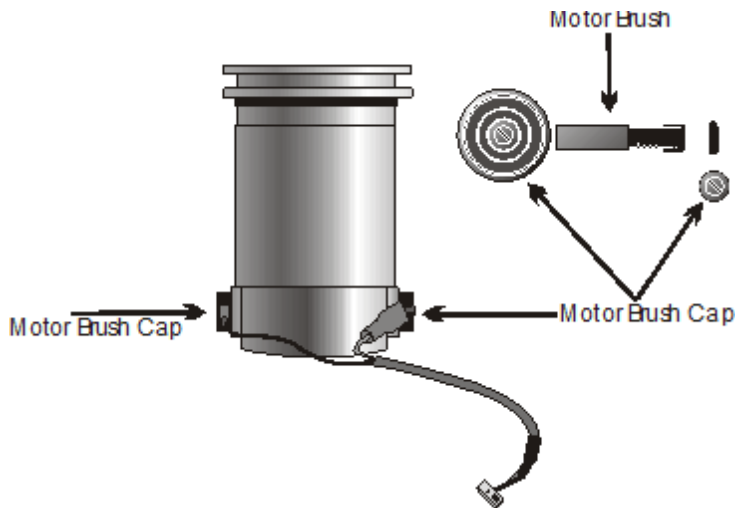

Install the new brush into the motor housing, replace the caps and machine covers.

## 6.6 Cleaning the Fan Filter

Weekly preventative maintenance should be performed to ensure reliable operation of your machine. It is recommended that the input fan filter be removed weekly and cleaned to ensure proper cooling of the electronics.

1. Unplug the power cable that goes into the back of the machine.
2. Remove the filter guard by using a small flat blade screwdriver to pop the guard open.
3. Remove the filter and blow out the filter with low-pressure compressed air.
4. Replace the filter and filter guard by snapping it back in place.

### Cooling Fan Filter and Cover



## 7 Troubleshooting

### 7.1 Engraving Problems

**Problem:** Engraving on the plate is "slanted".

**Possible solutions:**

1. Check material for squareness. Is the engraving material square?
2. Check to see if the material on the table is indeed at a true home and is square to your T-slot edge guides.
3. Check to insure that the T-slot edge guides are secure and flush to the T-Slot table. Hint: Always inspect the job before removing your plate from the system. You may be able to salvage it by re-engraving the job, or you may be able to analyze the problem and prevent repeating it. Perhaps the plate moved during engraving. Removing it without inspection would prevent you from detecting this problem.

**Problem:** When using a nose cone, the engraving is "shallow" across the top or left margin of your plate. It engraves properly when the spindle is away from the edge.

**Possible solutions:**

1. The nose cone is riding on the T-slot edge guides. Loosen and lower the edge guides so that they are below the level of your material surface. Re-tighten the thumbscrews.
2. Check to see if the material is riding on the T-slot edge guides. It's not hard to miss during set-up especially if the plate is thin material.

**Problem:** When using a nose cone, the engraving is uneven.

**Possible solutions:**

1. The spindle is not "zeroed" to your material.
2. When burnishing, there may not be enough pre-load set to adjust for material thickness changes. If using the Set Surface function to control engraving depth and not the Prox sensor, the surface position may not be low enough to consistently engrave. Increasing the Set Surface depth should correct the problem.
3. The engraving speed may be too fast for the type of material being engraved. Check the manufacturer's recommendation. The cutter may be bouncing on the surface. Some hard materials may exhibit this problem.
4. The cutter may be defective or broken. Replace it.
5. The material may be defective, or of poor quality.
6. The vacuum chip removal system may be plugged, or the hose is blocked and engraving chips are caught between the nose cone and the material.
7. The nose cone or vacuum nose is loose.

**Problem:** "Shadowing" occurs while engraving certain materials.

**Possible solutions:**

1. Leave the protective film on the engraving material during engraving.
2. Use a plastic nose cone instead of a metal one.

3. The nose cone may be damaged. Inspect for burrs or roughness. Try using an emery cloth to polish the nose.
4. Use less spindle spring pressure. Excessive down pressure will leave a rub mark on almost any plastic material.

**Problem:** You are not using a nose cone and you have uneven engraving.

**Possible solutions:**

1. Switch to a nose-riding method.
2. Use a different method of holding the material. If double-sided tape is being used, it may be thick enough to change your surface flatness and the engraving depth.
3. The T-slot table may not be flat, or has been installed improperly.
4. The table the machine is sitting on may not be a level surface.
5. Make sure the spindle spring pressure knob is locked all the way down.

**Hint:** While it's true that you can do non-nose riding engraving, it's not easy to hold any controlled accuracy on the depth. This takes flat material, a very flat table and some degree of skill and confidence. It also takes an application where some amount of uneven engraving may be tolerated.

**Problem:** There are "tails" or "swirls" in the corners of my engraving.

**Possible solutions:**

1. The cutter speed is too fast relative to your X-Y speed. Slow your spindle speed down or increase your table speed.
2. The cutter is worn or damaged. Replace it, or have it re-sharpened.

**Problem:** There is "fuzz", "fur" or lines in the bottom of my cut showing each cutter path. Steps are noticeable in the bottom of the cut.

**Possible solutions:**

1. This can be caused by dull cutters, the wrong cutter, or not enough overlap for each cut. Try changing cutter size slightly. You may get better clean up.
2. Try taking a second pass cut at .001-.002 deeper. This may clean up the roughness.
3. Resharpener the cutter. There are various cutter angles that can cause these kinds of problems. There is a relief angle that if too great can cause noticeable ridges in the bottom of the cut.
4. Ensure that the spindle is square in the mount or block. An out of square spindle means the cutter is not perpendicular to the material surface.
5. Turn the spindle RPM speed up.

**Problem:** Poor letter quality.

**Possible solutions:**

1. The engraving speed may be too fast. Engraving quality improves with the right engraving and spindle speeds.
2. When diamond drag engraving, there may be too much down pressure. Check the grain of the material; it should be left to right.
3. The cutter may be dull or worn.
4. The material is not securely fastened to the table.

**Problem:** Ragged engraved characters.

**Possible solutions:**

1. If the quality of cut is ragged or exhibits steps, there may be play in the cutter. This could be in the gap between the cutter and the spindle shaft. Maybe the shaft is worn or the spindle bearings need to be replaced. Once a shaft starts to wear and a cutter is loose, the problem can worsen quickly.
2. The spindle is loose in the housing or block.
3. The carriage is loose or has excessive play. Check the Z-Axis bearings or slide.
4. Lubricate the lead screws as explained in the Maintenance section.

**Problem:** My baseline is off.

**Possible solutions:**

1. The machine's home position may have changed. The table or carriage may have been bumped during set-up. Maybe the previous job was cut short and the system did not return back to its mechanical home or limit switches. Move the table, bridge or carriage physically to home or send it home via the software.
2. Check your software layout for errors.

**Problem:** While burnishing anodized aluminum, I have voids or non-engraved areas.

**Possible solutions:**

1. Try re-engraving the same plate again. Some anodized aluminum plates have a very hard surface and two passes are required.
2. Switch to a diamond burnisher. The more common carbide tools may have difficulty getting through the surface and are more easily worn, thus sometimes skipping across the surface.
3. Increase the pre-load of the burnishing adapter.
4. Try other materials. Same reasons as above. Some materials are too tough to engrave.

## 7.2 Mechanical Problems

**Problem:** No X, Y or Z-Axis movement.

**Possible solutions:**

1. Check that the power switch is on.
2. Check the power cable to make sure it is plugged in properly to the machine.
3. If the power cord is plugged in to a power strip, make sure that the power strip is working properly and turned on.
4. Check to make sure that the X-Y Speed knob on the front panel is turned all the way clockwise.
5. Ensure that the job has been transferred to the controller (Green Start button LED is flashing).

**Problem:** System has no movement in any one axis.

**Possible solutions:**

1. Try to jog the problem axis using the X/Y/Z jog keys on the front panel. If OK, retry the job.
2. There is possibly a bad drive board in the machine. Contact your distributor.

**Problem:** Unusually loud noises during the engraving process.

**Possible solutions:**

1. Make sure the cutter or nose cone is not loose.
2. Make sure the speed settings are correct for the material being cut.
3. Isolate the cause of the unusual noise. Perform a dry run with:
  - a. No changes to the machine.
  - b. The cutter removed.
  - c. The engraving motor turned OFF. This is done in the Cut Toolbox by turning the Spindle control to OFF. If the noise persists, it may be confined to the X, Y or Z-axis. Check for proper lubrication of lead screws. Follow lubrication instructions in the Maintenance section.

If the noise persists, further isolate the cause by doing the following:

- a. Remove the motor belt.
- b. Run the engraving motor without starting a job. Loose motor belts may cause some noises, so removal will narrow down the problem. If the noise is present with the spindle motor on, check the motor brushes. If there is no unusual noise when running the spindle motor with no belt attached, do the following:
  - a. Attach the motor belt.
  - b. Run the spindle motor and vary the RPM by turning the spindle speed control knob. Noise levels may vary. If the noise persists, check the spindle for overheating. Excessive overheating of the outside housing of the spindle is a sign of defective bearings. The noise may be caused by the bearings.

**Problem:** Spindle is hot.

**Possible solutions:**

1. Ensure that the nose cone area is free of debris. Check the vacuum system (if used) for clogging.

2. Inspect the spindle for other obstructions that may prevent proper rotation.
3. The spindle bearings may need to be replaced.

**Problem:** Spindle motor will not turn on.

**Possible solutions:**

1. Check motor brushes.

**Problem:** Motor belt will not stay on pulley.

**Possible solutions:**

1. Motor belt is probably worn and needs to be replaced.

## 8 Optional Accessories

These accessories are available for purchase directly from Vision, or your local distributor, as well as through [www.visionengravers.com](http://www.visionengravers.com). If you have any questions about these accessories, please contact Vision or your distributor for advice for choosing the best accessories for your applications. Vision can also help if you have a need for special fixtures, or modifications to our standard accessories. Please call us for details.

### 8.1 Vacuum Chip Removal System

The process of engraving or cutting plastics, acrylics, sign foam and wood, produce a significant amount of debris that can clog the nose cone and/or get trapped between the nose cone and the material, which will cause engraving/cutting depth inconsistencies as well as potentially scratch the surface of the material. The vacuum chip removal system is designed to simplify the engraving process and minimize wear and tear on the engraver. It uses a vacuum nose cone to remove chips created during the engraving process before they have the chance to create problems. The quiet pump, coupled with the microfinelayered filters assures that your unwanted chips are whisked away effortlessly. The vacuum pump canister uses replaceable/reusable filters to assure maximum efficiency and cost-effectiveness.

The system allows prompt removal of chips and dust created in the engraving process, reducing contamination and overheating in the spindle area. Chip removal also prevents the cutter from skipping over letters due to stray particles. This vacuum chip removal system is available with or without a Vision vacuum nose cone.

#### The Optional Vacuum Chip Removal System





## 8.2 Quick Lock Vise

The Quick Lock Vise is used to clamp rigid materials against the top Edge Guide in order to prevent movement. This is an alternate method for holding down materials.

Put the material you would like to engrave on the t-slot table and push it to the home position corner. Next, loosen the quick lock vise locking screw and slide the quick lock vise so that there is about 1/16th inch gap between the edge of the vise and the material. Tighten the quick lock vise locking screw. Once this is done, the material can easily be secured by turning the quick lock vise handle. When changing the engraving material, simply loosen the quick lock vise handle, remove the engraved material, put the new material in and tighten up the quick lock handle.

**Note:** For larger pieces of material, you may need to put a small piece of double-sided tape on the tslot table in the middle of the engraving material. This will keep the material from bowing in the center.

The quick lock vise will only work on square or rectangular material. To hold down irregular shaped objects, you must use some other method. Ask your Vision Distributor or Vision if you need more information on this feature.

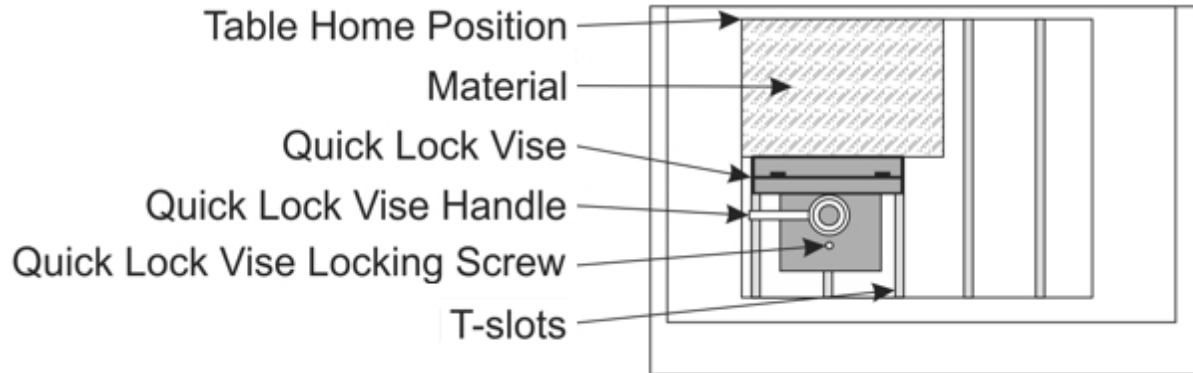

## 8.3 Hold Down Clamps

### Wedge Clamps

Simply slide the clamp onto the T-slot table surface and position it over the edge of the engraving stock. The downward clamping force eliminates bowing. This clamp can be used with material up to 1/4" thick.



### Push Down Clamps

This double-sided clamp secures items from the edge. It is ideal for heavy-duty items that are being cut, contoured or engraved.



### Edge Clamps

This clamp is designed to secure engraving materials from the top surface and avoids bowing in most applications. This clamp will hold material thicknesses of .020, .032, .062, and .125 by rotating the clamp and tightening a thumbscrew.



### Corner Clamps

This clamp is designed to hold down square or rectangular plates. By lining up the "V" cut-out of the clamp with the corner of the plate, the engraver is allowed maximum engraving space. It will hold material as thin as 1/32".



## 8.4 Fixtures

### Universal Pin Fixtures

Available for the Versa Vise, T-slot table, and Self-Centering Vise. Also usable with other computerized engravers and Pantographs. These fixtures enable engraving on uniquely shaped items such as pens, lighters, knives, keychains, and more.



### Universal Clamping Bars w/Medallion Holder

These clamping bars hold 1 to 3 round objects at a time. Engrave multiple notary seals, paperweights, and a variety of other circular items. With a place for the “eye” of medallions, this clamp adapts to any vise or table that has a T-slot system.



### Seal Fixture

The Seal Fixture enables engraving on notary seals, medallions, coasters, paperweights, dog tags, and other round objects. Usable with the Quick-Lock or Versa Vise.



### Adjustable Pen Fixture

Enables engraving on most pens and cylindrical items that vary in diameter from end to end. Available for most computerized engravers and Pantographs. It is also usable with the Versa Vise and Self-Centering Vise.

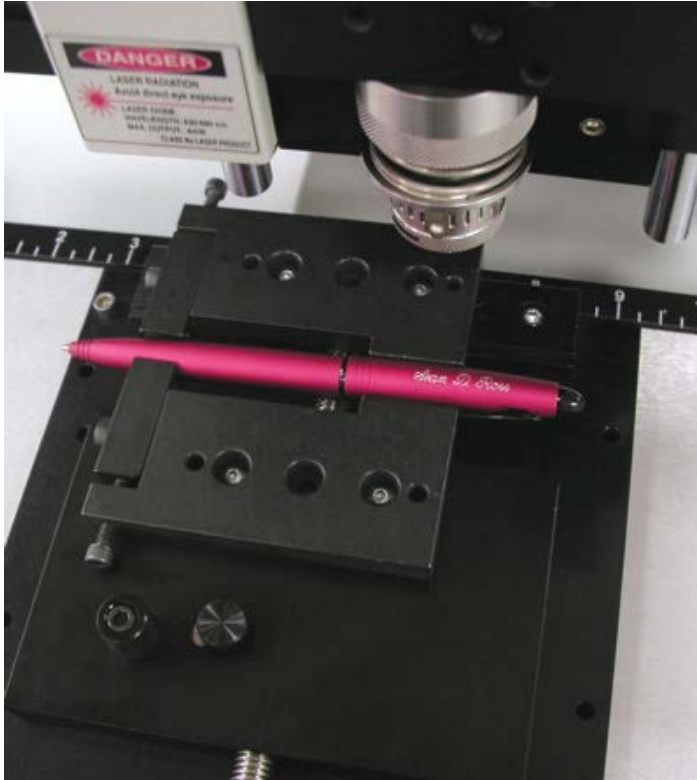

### Pen & Medallion Fixture

This is a double-sided fixture that, when turned in one direction, accommodates a pen, and when turned in the other direction, accommodates a medallion, seal, or other circular item. With a space for the “eye” of the medallion, this fixture is usable with the Versa Vise or Quick-Lock Vise.

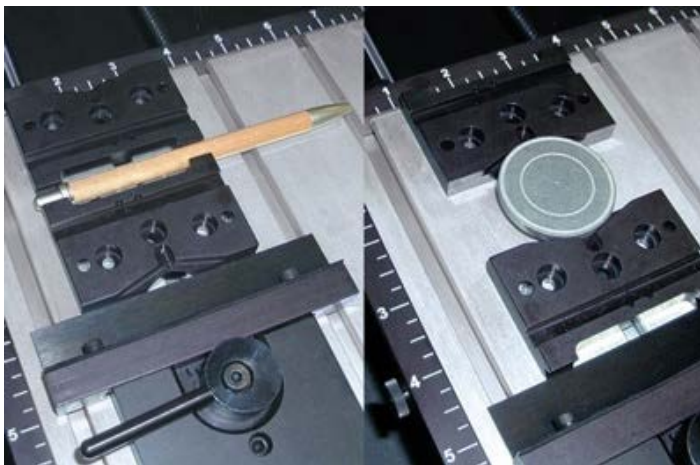



## 8.5 Clamping Visers

### Quick Lock Vise

The Quick-Lock Vise is specifically designed for T-slot table users. The “cam” type locking device allows for quick changing of parts. This vise is supplied with a removable front clamping plate which allows for the holding of thicker items.

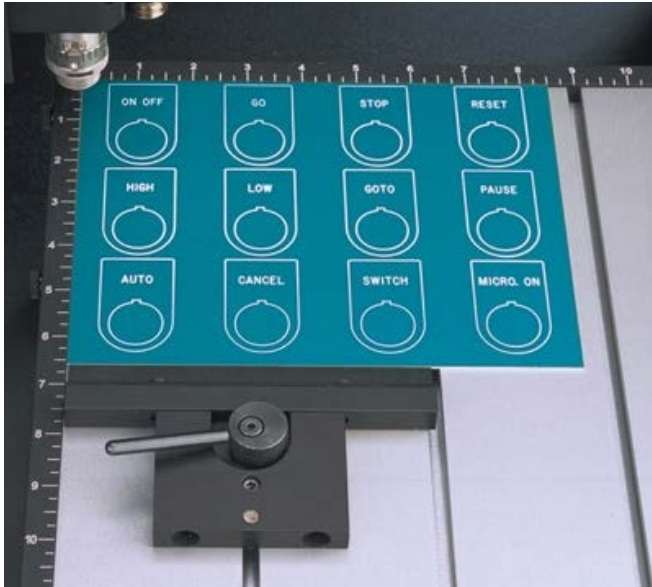

### Self-Centering Deep Vise

This self-centering vise allows for easy setup of odd-shaped items up to 3 1/4” deep.

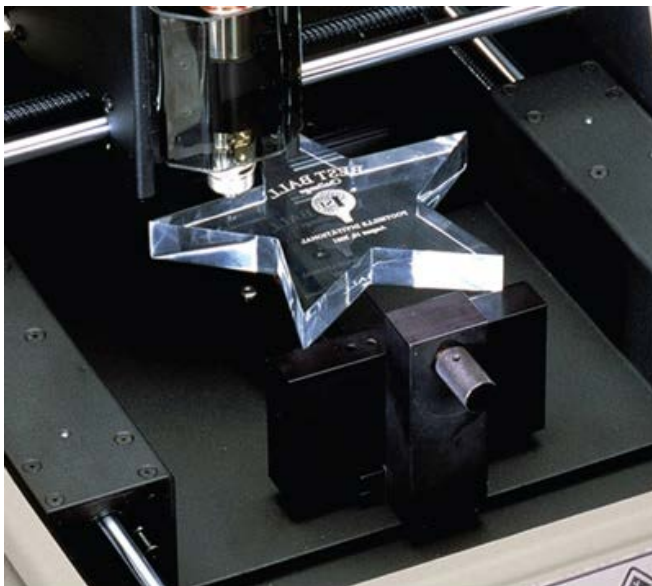

### Small Self-Centering Vise

This fixture allows you to hold various small items such as nameplates, signs and placards. Dowel pin settings allow this item to work with most Vision fixtures for even more versatility.







